

# **marantz®**

**Model SR5300 User Guide**

---

AV Surround Receiver

## ENGLISH

### WARRANTY

For warranty information, contact your local Marantz distributor.

#### RETAIN YOUR PURCHASE RECEIPT

Your purchase receipt is your permanent record of a valuable purchase. It should be kept in a safe place to be referred to as necessary for insurance purposes or when corresponding with Marantz.

#### IMPORTANT

When seeking warranty service, it is the responsibility of the consumer to establish proof and date of purchase. Your purchase receipt or invoice is adequate for such proof.

#### FOR U.K. ONLY

This undertaking is in addition to a consumer's statutory rights and does not affect those rights in any way.

## FRANÇAIS

### GARANTIE

Pour des informations sur la garantie, contacter le distributeur local Marantz.

#### CONSERVER L'ATTESTATION D'ACHAT

L'attestation d'achat est la preuve permanente d'un achat de valeur. La conserver en lieu sûr pour s'y reporter aux fins d'obtention d'une couverture d'assurance ou dans le cadre de correspondances avec Marantz.

#### IMPORTANT

Pour l'obtention d'un service couvert par la garantie, il incombe au client d'établir la preuve de l'achat et d'en corroborer la date. Le reçu ou la facture constituent des preuves suffisantes.

## DEUTSCH

### GARANTIE

Bei Garantiefragen wenden Sie sich bitte an Ihren Marantz-Händler.

#### HEBEN SIE IHRE QUITTING GUT AUF

Die Quittung dient Ihnen als bleibende Unterlage für Ihren wertvollen Einkauf. Das Aufbewahren der Quittung ist wichtig, da die darin enthaltenen Angaben für Versicherungswecke oder bei Korrespondenz mit Marantz angeführt werden müssen.

#### WICHTIG!

Bei Garantiefragen muß der Kunde eine Kaufunterlage mit Kaufdatum vorlegen. Ihren Quittung oder Rechnung ist als Unterlage ausreichend.

## NEDERLANDS

### GARANTIE

Voor inlichtingen omtrent garantie dient u zich tot uw plaatselijke Marantz.

#### UW KWITANTIE, KASSABON E.D. BEWAREN

Uw kwitantie, kassabon e.d. vormen uw bewijs van aankoop van een waardevol artikel en dienen op een veilige plaats bewaard te worden voor evt. verwijzing bijv. in verbend met verzekering of bij correspondentie met Marantz.

#### BELANGRIJK

Bij een evt. beroep op de garantie is het de verantwoordelijkheid van de consument een gedateerd bewijs van aankoop te tonen. Uw kassabon of factuur zijn voldoende bewijs.

## ESPAÑOL

### GARANTIA

Para obtener información acerca de la garantía póngase en contacto con su distribuidor Marantz.

#### GUARDE SU RECIBO DE COMPRA

Su recibo de compra es su prueba permanente de haber adquirido un aparato de valor. Este recibo deberá guardarlo en un lugar seguro y utilizarlo como referencia cuando tenga que hacer uso del seguro o se ponga en contacto con Marantz.

#### IMPORTANTE

Quando solicitar el servicio otorgado por la garantía el usuario tiene la responsabilidad de demostrar cuándo efectuó la compra. En este caso, su recibo de compra será la prueba apropiada.

## ITALIANO

### GARANZIA

L'apparecchio è coperto da una garanzia di buon funzionamento della durata di un anno, o del periodo previsto dalla legge, a partire dalla data di acquisto comprovata da un documento attestante il nominativo del Rivenditore e la data di vendita. La garanzia sarà prestata con la sostituzione o la riparazione gratuita delle parti difettose.

Non sono coperti da garanzia difetti derivanti da uso improprio, errata installazione, manutenzione effettuata da personale non autorizzato o, comunque, da circostanze che non possano riferirsi a difetti di funzionamento dell'apparecchio. Sono inoltre esclusi dalla garanzia gli interventi inerenti l'installazione e l'allacciamento agli impianti di alimentazione.

Gli apparecchi verranno riparati presso i nostri Centri di Assistenza Autorizzati. Le spese ed i rischi di trasporto sono a carico del cliente.

La casa costruttrice declina ogni responsabilità per danni diretti o indiretti provocati dalla inosservanza delle prescrizioni di installazione, uso e manutenzione dettagliate nel presente manuale o per guasti dovuti ad uso continuato a fini professionali.

## PORTUGUÊS

### GARANTIA

Para informações sobre a garantia, contactar o distribuidor Marantz local.

#### GUARDAR O RECIBO DE COMPRA

O recibo é o registo permanente da compra que fez. Deve ser guardado num local seguro, para ser apresentado em questões relacionadas com o seguro ou para quando tiver de contactar a Marantz.

#### IMPORTANTE

Quando procurar assistência técnica ao abrigo da garantia, é da responsabilidade do consumidor estabelecer a prova e data de compra.

O recibo é prova adequada.

## SVENSKA

### GARANTI

För information om garantin, kontakta Marantz lokalgagent.

#### SPAR KVITTOT

Kvittot är ett inköpsbevis på en värdefull vara. Det skall förvaras säkert och hänvisas till vid försäkringsfall eller vidkorrespondens mod Marantz.

#### VIKTIGT

Fö att garantin skall gälla är det kundens sak att framställa bevis och datum om köpet. Kvitto eller faktura är tillräckligt bevis för detta.

## DANSK

### GARANTI

Henvend dem til Deres MARANTZ-forhandler angående information om garantien.

#### GEM DERES KVITTERING

Deres købskvittering er Deres varige bevis på et dyrt køb. Den bør gemmes godt og anvendes som bevis, hvis De vil tegne en forsikring, eller hvis De kommunikerer med Marantz.

#### VIGTIGT

Det påhviler forbrugeren at skaffe bevis for købet og købsdatoen, hvis han eller hun ønsker garantiservice. Deres købskvittering eller faktura er et fuldgældigt bevis herpå.

# CE MARKING

- English**  
The SR5300 is in conformity with the EMC directive and low-voltage directive.
- Français**  
Le SR5300 est conforme à la directive EMC et à la directive sur les basses tensions.
- Deutsch**  
Das Modell SR5300 entspricht den EMC-Richtlinien und den Richtlinien für Niederspannungsgeräte.
- Nederlands**  
De SR5300 voldoet aan de EMC eisen en de vereisten voor laag-voltage.
- Español**  
El SR5300 está de acuerdo con las normas EMC y las relacionadas con baja tensión.
- Italiano**  
Il SR5300 è conforme alle direttive CEE ed a quelle per i bassi voltaggi.
- Português**  
O SR5300 conforma com as diretrizes EMC e de baixa voltagem.
- Svenska**  
SR5300 är tillverkad i enlighet med EMC direktiven och direktiven för lågvoltsutrusning.
- Dansk**  
Model SR5300 er i overensstemmelse med EMC-direktivet og direktivet om lavspænding.

## English

To ventilate the unit, do not install the unit in a rack or bookshelf, and note the followings.

- Do not touch the top of the enclosure during operation.
- Do not block the openings in the enclosure during operation.
- Do not insert objects beneath the unit.
- Do not block the ventilation slots at the top of the unit.
- Do not place anything about 1 meter above the top panel.
- Make a space of about 0.2 meter around the unit.

## Français

Pour que l'appareil puisse être correctement ventilé, ne pas l'installer dans un meuble ou une bibliothèque et respecter ce qui suit.

- Ne pas toucher le dessus du coffret.
- Ne pas obstruer les ouïes de ventilation du coffret pendant le fonctionnement.
- Ne placer aucun objet sous l'appareil.
- Ne pas obstruer les ouïes de ventilation du panneau supérieur. Ne placer aucun objet à moins d'un mètre environ du panneau supérieur.
- Veiller à ce qu'aucun objet ne soit à moins de 0,2 mètre des côtés de l'appareil.

## Deutsch

Um eine einwandfreie Belüftung des Geräts zu gewährleisten, darf das Gerät nicht in einem Gestell oder Bücherregal aufgestellt werden; die folgenden Punkte sind besonders zu beachten:

- Während des Betriebs das Oberteil des Gehäuses nicht berühren.
- Während des Betriebs die Öffnungen im Gehäuse nicht blockieren.
- Keine Gegenstände in das Gerät einführen.
- Die Belüftungsschlitze an der Oberseite des Geräts dürfen nicht blockiert werden. Darauf achten, daß über dem Gerät ein Freiraum von mindestens 1 meter vorhanden ist.
- Auf allen Geräteseiten muß ein Zwischenraum von ungefähr 0,2 meter vorhanden sein.

## Nederlands

Installeer het toestel niet in een rek of boekenkast waar de ventilatie mogelijk wordt gehinderd. Let tevens op de volgende punten:

- Raak de bovenkant van het toestel niet aan als het in gebruik is.
- Blokkeer de openingen van het toestel niet als het in gebruik is.
- Plaats geen onderwerpen onder het toestel.
- Blokkeer de ventilatie-openingen aan de bovenkant van het toestel niet. Zorg dat er tenminste 1 meter vrije ruimte boven het toestel is.
- Zorg dat er 0,2 meter vrije ruimte rond het toestel is.

## Español

Para ventilar la unidad no la instale en una estantería ni estante para libros, y tenga en cuenta lo siguiente:

- No toque la parte superior de la caja durante el funcionamiento.
- No tape las ranuras en la caja durante el funcionamiento.
- No ponga objetos debajo de la unidad.
- No tape las ranuras de ventilación de la parte superior de la unidad. No ponga nada a menos de 1 metro por encima del panel superior.
- Deje un espacio de unos 0,2 metro alrededor de la unidad.

## Italiano

Perché l'unità possa essere sempre ben ventilata, non installarla in scaffali o librerie e tenere presente quanto segue.

- Non toccare la parte superiore del rivestimento durante il funzionamento.
- Non bloccare le aperture sul rivestimento durante il funzionamento.
- Non inserire oggetti al di sotto dell'unità.
- Non bloccare le fessure di ventilazione sopra l'unità. Non posare nulla per circa un metro sopra il pannello superiore.
- Lasciare 0,2 metro liberi tutto intorno l'unità.

## Português

Para ventilar o aparelho, não instalá-lo dentro duma estante ou algo similar, e observar as seguintes recomendações:

- Não tocar a parte superior do aparelho durante a operação.
- Não bloquear as aberturas do aparelho durante a operação.
- Não inserir objectos debaixo do aparelho.
- Não bloquear as aberturas de ventilação na parte de cima do aparelho. Deixar um espaço completamente livre de cerca de 1 metro acima do painel superior.
- Deixar um espaço de cerca de 0,2 metro ao redor do aparelho.

## Svenska

För att ventilera enheten, ställ den inte i ett ställ eller bokhylla och tänk på följande.

- Vidrör inte ytterhöljets ovansida under pågående drift.
- Blockera inte öppningarna i ytterhöljet under pågående drift.
- Stick inte in föremål under enheten.
- Blockera inte ventilationshålen ovanpå enheten. Placera inte någonting närmare än 1 meter ovanför apparaten eller enheten.
- Se till att det finns omkring 0,2 meter fri plats runt omkring enheten.

## Dansk

Anbring ikke apparatet i et rack eller en boghylde, da dette kan bloke luftcirkulationen omkring apparatet. Iagttag ligeledes følgende:

- Berør ikke oversiden af kabinettet under anvendelsen.
- Bloker ikke åbningerne i kabinettet under anvendelsen.
- Stik ikke genstande ind under apparatet.
- Bloker ikke ventilationsåbningerne ovenpå apparatet. Anbring ikke noget nærmere end 1 m over apparatets overside.
- Sørg for, at der er et frit område på omkring 0,2 m omkring apparatet.

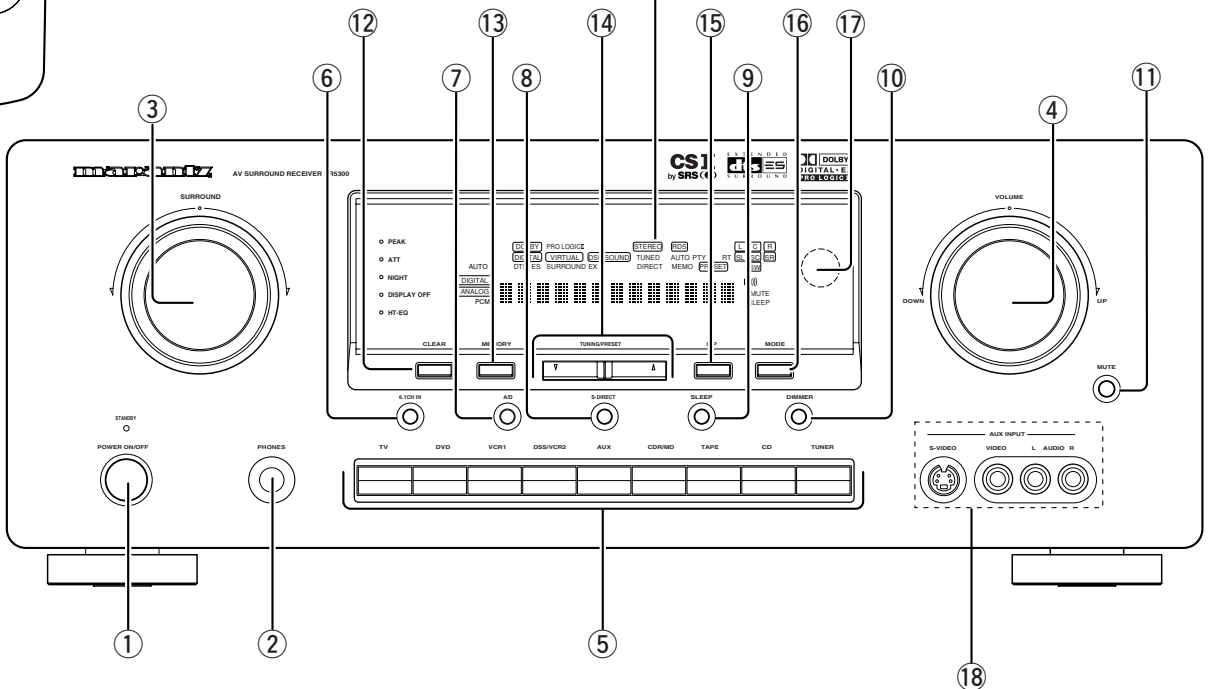
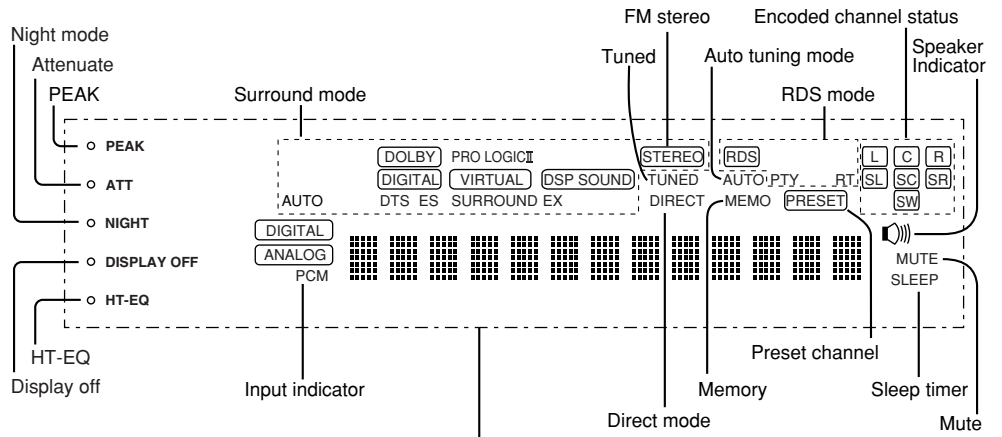
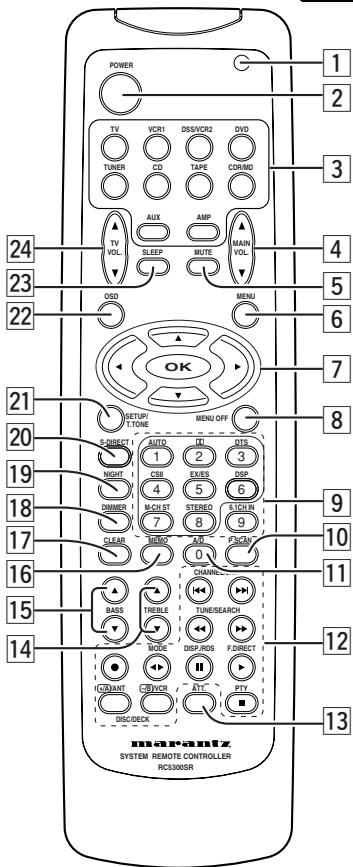
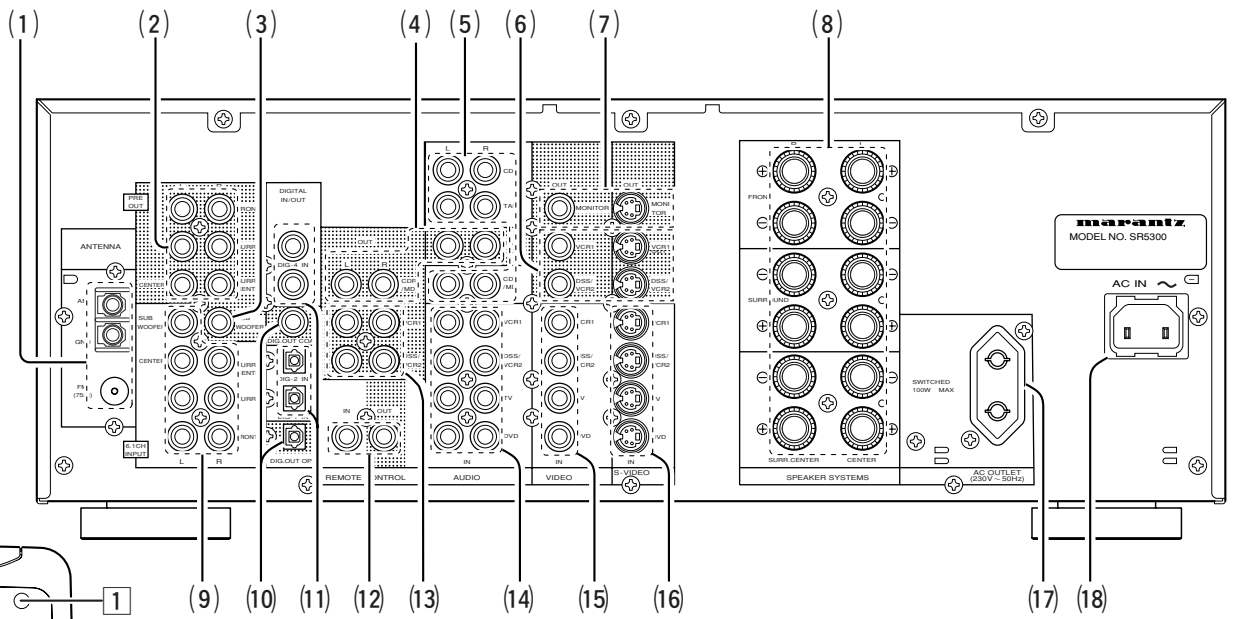

# **TABLE OF CONTENTS**

**FOREWORD ..... 2**  
 PRECAUTIONS .....2  
 INSTALLATION .....2

**INTRODUCTION..... 3**

**DESCRIPTION..... 3**

**FEATURES ..... 4**

**FRONT PANEL FEATURES ..... 5**

**REAR PANEL CONNECTIONS..... 6**

**REMOTE CONTROL OPERATION ..... 7**  
 OPERATION .....7  
 FUNCTION AND OPERATION .....7  
 PROGRAMMING THE REMOTE CONTROLLER .....8  
 OPERATION OF REMOTE CONTROL UNIT .....9

**CONNECTIONS..... 10**  
 SPEAKER PLACEMENT ..... 10  
 CONNECTING SPEAKERS ..... 11  
 CONNECTING AUDIO COMPONENTS ..... 12  
 CONNECTING VIDEO COMPONENTS ..... 13  
 ADVANCED CONNECTING ..... 14  
 CONNECTING REMOTE CONTROL JACKS ..... 14  
 CONNECTING THE ANTENNA TERMINALS ..... 15

**SETUP ..... 16**  
 ON SCREEN DISPLAY MENU SYSTEM ..... 16  
 INPUT SETUP (ASSIGNABLE DIGITAL INPUT) ..... 17  
 SPEAKER SETUP ..... 17  
 PREFERENCE ..... 19  
 SURROUND ..... 19  
 PL2 (PRO LOGIC II) MUSIC PARAMETER ..... 19  
 CS2 (CIRCLE SURROUND II) PARAMETER .....20  
 6.1 CH INPUT LEVEL .....20

**BASIC OPERATION ..... 21**  
 LISTENING TO THE TUNER .....21  
 RDS OPERATION .....22  
 PLAYBACK OPERATION .....23  
 TV AUTO ON/OFF FUNCTION .....23  
 SETTING THE SLEEP TIMER .....23

**ON SCREEN DISPLAY INFOMATION ..... 24**

**SURROUND MODE..... 25**

**TROUBLE SHOOTING ..... 29**

**TECHNICAL SPECIFICATIONS..... 31**

**DIMENSION..... 31**

## FOREWORD

This section must be read before any connection is made to the mains supply.

### WARNINGS

- Do not expose the equipment to rain or moisture.
- Do not remove the cover from the equipment.
- Do not insert anything into the equipment through the ventilation holes.
- Do not handle the mains lead with wet hands.
- Do not cover the ventilation with any items such as tablecloths, newspapers, curtains, etc.
- No naked flame sources, such as lighted candles, should be placed on the equipment.
- When disposing of used batteries, please comply with governmental regulations or environmental public instruction's rules that apply in your country or area.

### EQUIPMENT MAINS WORKING SETTING

Your Marantz product has been prepared to comply with the household power and safety requirements that exist in your area. SR5300 can be powered by 230 V AC only.

### COPYRIGHT

Recording and playback of any material may require consent. For further information refer to the following:

- Copyright Act 1956
- Dramatic and Musical Performers Act 1958
- Performers Protection Acts 1963 and 1972
- any subsequent statutory enactments and orders

### ABOUT THIS USER GUIDE

Refer to the figures on page iii of this user guide. The numbers on the figures correspond to those in the text. All references to the connections and controls that are printed in **BOLD** type are as they appear on the unit.

## PRECAUTIONS

The following precautions should be taken when operating the equipment.

### GENERAL PRECAUTIONS

When siting the equipment ensure that:

- the ventilation holes are not covered;
- air is allowed to circulate freely around the equipment
- it is on a vibration free-surface;
- it will not be exposed to interference from an external source;
- it will not be exposed to excessive heat, cold, moisture or dust;
- it will not be exposed to direct sunlight;
- it will not be exposed to electrostatic discharges

Never place heavy objects on the equipment.

If a foreign body or water does enter the equipment, contact your nearest dealer or service center.

Do not pull out the plug by pulling on the mains lead, hold the plug.

It is advisable when leaving the house, or during a thunderstorm, to disconnect the equipment from the mains supply.

### PRECAUTIONS IN CONNECTION

- Be sure to unplug the power cable from the AC outlet or turn off the POWER switch before proceeding with any connection.
- Connect one cable at a time observing the "input" and "output". This will avoid any cross connection between channels and signal inputs and outputs.
- Insert the plugs securely. Incomplete connection may result in noise.
- Prior to connecting other audio and video equipment to the SR5300, please read their owner's manuals.

## INSTALLATION

If this unit or another electronic device incorporating a microcomputer is used at the same time with the tuner or television, picture disturbance or noise may occur. In such a case, install the unit according to the following guide points.

- Separate the unit as far as possible from the television.
- Place the antenna wire for the tuner or TV apart from the power cable and audio and video connection cables of this unit.
- Since the phenomenon is likely to occur when using an indoor antenna and/or 300-ohm feeder wire, we recommend using an outdoor antenna and 75-ohm coaxial cable.

# INTRODUCTION

Thank you for purchasing the Marantz SR5300 DTS/Dolby Digital Surround receiver.

This remarkable component has been engineered to provide you with many years of home theater enjoyment.

Please take a few minutes to read this manual thoroughly before you connect and operate the SR5300.

As there are a number of connection and configurations options, you are encouraged to discuss your own particular home theater setup with your Marantz A/V specialist dealer.

# DESCRIPTION



DTS was introduced in 1994 to provide 5.1 channels of discrete digital audio into home theater systems.

DTS brings you premium quality discrete multi-channel digital sound to both movies and music.

DTS is a multi-channel sound system designed to create full range digital sound reproduction.

The no compromise DTS digital process sets the standard of quality for cinema sound by delivering an exact copy

of the studio master recordings to neighborhood and home theaters.

Now, every moviegoer can hear the sound exactly as the moviemaker intended.

DTS can be enjoyed in the home for either movies or music on of DVD's, LD's, and CD's.

"DTS" and "DTS Digital Surround" are registered trademarks of Digital Theater Systems, Inc.



DTS-ES Extended Surround is a new multi-channel digital signal format developed by Digital Theater Systems Inc. While offering high compatibility with the conventional DTS Digital Surround format, DTS-ES Extended Surround greatly improves the 360-degree surround impression and space expression thanks to further expanded surround signals. This format has been used professionally in movie theaters since 1999.

In addition to the 5.1 surround channels (FL, FR, C, SL, SR and LFE), DTS-ES Extended Surround also offers the SC (Surround Center) channel for surround playback with a total of 6.1 channels. DTS-ES Extended Surround includes two signal formats with different surround signal recording methods, as DTS-ES Discrete 6.1 and DTS-ES Matrix 6.1.

"DTS", "DTS-ES Extended Surround" and "Neo:6" are trademarks of Digital Theater Systems, Inc.



Dolby Digital identifies the use of Dolby Digital (AC-3) audio coding for such consumer formats as DVD and DTV. As with film sound, Dolby Digital can provide up to five full-range channels for left, center, and right screen channels, independent left and right surround channels, and a sixth (".1") channel for low-frequency effects.

Dolby Surround Pro Logic II is an improved matrix decoding technology that provides better spatiality and directionality on Dolby Surround program material; provides a convincing three-dimensional soundfield on conventional stereo music recordings; and is ideally suited to bring the surround experience to automotive sound. While conventional surround programming is fully compatible with Dolby Surround Pro Logic II decoders, soundtracks will be able to be encoded specifically to take full advantage of Pro Logic II playback, including separate left and right surround channels. (Such material is also compatible with conventional Pro Logic decoders.)

Dolby Digital EX creates six full-bandwidth output channels from 5.1-channel sources. This is done using a matrix decoder that derives three surround channels from the two in the original recording. For best results, Dolby Digital EX should be used with movies soundtracks recorded with Dolby Digital Surround EX.

Manufactured under license from Dolby Laboratories. "Dolby", "Pro Logic", and the double-D symbol are trademarks of Dolby Laboratories.



Circle Surround II (CS-II) is a powerful and versatile multi-channel technology. CS-II is designed to enable up to 6.1 multi-channel surround sound playback from mono, stereo, CS encoded sources and other matrix encoded sources. In all cases the decoder extends it into 6 channels of surround audio and a LFE/subwoofer signal. The CS-II decoder creates a listening environment that places the listener "inside" music performances and dramatically improves both hi-fi audio conventional surround-encoded video material. CS-II provides composite stereo rear channels to greatly improve separation and image positioning – adding a heightened sense of realism to both audio and A/V productions.

CS-II is packed with other useful feature like dialog clarity (SRS Dialog) for movies and cinema-like bass enrichment (TruBass). CS-II can enable the dialog to become clearer and more discernable in movies and it enables the bass frequencies contained in the original programming to more closely achieve low frequencies – overcoming the low frequency limitations of the speakers by full octave.

SRS Circle Surround II, SRS Dialog, SRS TruBass, SRS and  are trademarks of SRS Labs, Inc.

SRS Circle Surround II, SRS Dialog and SRS TruBass technology are incorporated under license from SRS Labs, Inc.



## FEATURES

### **BUILT-IN 6 CHANNEL POWER AMPLIFIER**

90 watts to each of the six main channels ; the power amp section features an advanced, premium high- storage power supply capacitors, and fully discrete output stages housed in cast aluminum heat sinks .

### **192 KHZ/24-BIT D/A CONVERTER FOR ALL CHANNELS**

### **DTS-ES**

**DTS-ES** decoder built in to decode the impeccable 6.1-channel discrete digital audio from DTS-ES encoded DVD-Video discs, DVD-Audio discs and CDs.

### **DOLBY DIGITAL EX**

**Dolby Digital EX** decoder built in to create six full-band width output channels from the 5.1-channel digital audio of DVDs, Digital TV, HDTV, satellite broadcasts and other sources.

### **DOLBY PRO LOGIC II**

**Dolby Pro Logic II** decoder provides better spatiality and directionality on Dolby Surround program material; provides a convincing three-dimensional sound field on conventional stereo music recordings.

### **DTS-NEO6**

**DTS-Neo6** decoder built in to decode 6.1-channel surround sound from any stereo material.

### **CIRCLE SURROUND II**

**CIRCLE SURROUND II** decoder built in to decode 6.1-channel surround sound from any stereo or passive matrix-encoded material.

### **SOURCE DIRECT MODE**

**Source Direct mode** bypasses, tone controls and bass management for purest audio quality.

### **6.1 CHANNEL PRE-AMP OUTPUTS**

**6.1 channel pre-amp outputs** for connection to external components such as a subwoofer and external power amplifiers.

### **MULTI-CHANNEL 6.1CH DIRECT INPUT**

**Multi-channel (6.1ch)direct inputs** accommodate future multi-channel sound formats or an external digital decoder.

### **4 DIGITAL INPUTS AND 2 DIGITAL OUTPUTS**

**4 Digital inputs** for connection to other sources, such as DVD, DSS, CD, CD-R or MD.

**2 Digital outputs** for connection to CD-R or MD.

### **30 STATION RANDOM ACCESS PRESET TUNING**

High-quality AM/FM tuner with 30 station random access preset tuning.

### **RDS FUNCTION**

**Radio Data System(RDS)** provides information on FM broadcasts.

### **ONSCREEN DISPLAY MENU SYSTEM**

Easy to **use on-screen display menu system** in all video monitor output.



# FRONT PANEL FEATURES (SEE PAGE iii.)

## ① POWER switch and STANDBY indicator

Press the button to turn the power ON, and press again to turn it OFF. If the **POWER** switch is in the ON position, the power of this unit can be turned ON/OFF by pressing the **POWER** button on the remote control unit.

When this unit is in the standby mode with the **POWER** switch set to the ON position, pressing one of the **FUNCTION SELECTOR** buttons also allows to turn the power on.

The **STANDBY** indicator lights up when this unit is the standby mode (power OFF) by the remote control unit.

## ② PHONES jack for stereo headphones

Conventional dynamic headphones can be plugged in here.

### Notes:

- When using headphones, the surround mode is switched automatically to **STEREO**, the sound from the speakers is muted and the “” indicator is turned off.
- The surround mode returns to the previous setting as soon as the plug is removed from the jack.

## ③ SURROUND mode selector knob

When this knob is turned, the surround mode is switched sequentially.

## ④ VOLUME control knob

Adjusts the over all sound level. Turning the control clockwise increases the sound level.

## ⑤ Function selector buttons (Audio/ Video)

These buttons are used to select the sources.

The video function selector, such as TV, DVD, VCR1, DSS/VCR2, and AUX, selects video and audio simultaneously.

Audio function sources such as CD, TAPE, CDR/MD, and TUNER may be selected in conjunction with a Video source.

This feature (Sound Injection) combines a sound from one source with a picture from another.

Choose the video source first, and then choose a different audio source to activate this function.

## ⑥ 6.1CH IN button

Press this button to select the output of an external multi channel decoder.

## ⑦ A/D (Analog/Digital) SELECTOR button

This is used to select between the analog and digital inputs.

### Note:

- This button is not used for an input source that is not connected to a digital input.

## ⑧ S. ( Source) DIRECT button

When this button is pressed, the tone control circuit is bypassed as well as Bass Management.

### Notes:

- The surround mode is automatically switched to **AUTO** when the source direct function is turned on.
- Additionally, Speaker Configurations are fixed automatically as follow.  
Front SPKR = LARGE  
Center SPKR = LARGE  
Surround SPKR = LARGE  
Surround Center SPKR = YES  
Sub woofer = YES
- S.DIRECT is turned off when the other surround mode is selected with the **SURROUND** mode selector knob or the surround mode buttons of the remote controller.

## ⑨ SLEEP (Sleep timer) button

Set the sleep timer function with this button .

## ⑩ DIMMER button

When this button is pressed once, the display is dimmed.

When this button is pressed twice, the display is turned off and “DISPLAY OFF” indicator lights up.

Press this button again to turn the display ON again.

## ⑪ MUTE button

Press this button to mute the output to the speakers. Press it again to return to the previous volume level.

## ⑫ CLEAR button

Press this button to cancel the station memory setting mode or preset scan tuning.

## ⑬ MEMORY button

Press this button to enter the tuner preset memory numbers and station names.

## ⑭ TUNING / PRESET UP and DOWN buttons

During reception of AM or FM, you can scan the other frequencies or select another preset station pressing these buttons.

## ⑮ F/P (Frequency/ Preset) button

During reception of AM or FM, you can change the function of the UP/DOWN buttons for scanning frequencies or selecting preset stations by pressing this button.

## ⑯ (FM) MODE button

Press this button to select the auto stereo mode or mono mode when the FM band is selected. The **AUTO** indicator lights in the auto stereo mode.

## ⑰ Infrared sensor

This window receives infrared signals from the remote control unit.

## ⑱ AUX input jacks

These auxiliary video/audio input jacks accept the connection of a camcorder, portable VCR, etc.

## REAR PANEL CONNECTIONS (SEE PAGE iii.)

All connections to the rear panel should be made with the entire system powered off.

To avoid errors, it is advisable to connect one cable at a time between the various components.

### (1) FM antenna terminal (75 ohms)

Connect an external FM antenna with a coaxial cable, or a cable network FM source.

#### AM antenna and ground terminals

Connect the supplied AM loop antenna. Use the terminals marked "AM" and "GND".

The supplied AM loop antenna will provide good AM reception in most areas.

Position the loop antenna until you hear the best reception.

### (2) PRE OUT jacks

Jacks for Front - L/R, Center, Surround and Surround center. Use these jacks for connection to an external power amplifier.

### (3) SUB WOOFER output jack

Connect to the input jack(s) of the power amplifier for subwoofer channel or powered subwoofer.

### (4) Analog AUDIO outputs for audio recording equipment

#### TAPE and CD-R/MD

Connect each output to the audio inputs (REC in) of your recording equipment.

### (5) Analog AUDIO inputs

#### CD, TAPE, and CD-R/MD

Connect the audio outputs of your source components to the input jacks on the receiver.

### (6) VIDEO (VIDEO/S-VIDEO) outputs

#### VCR1, and DSS/VCR2

Connect each output to the video input (REC in) of your video recording equipment.

### (7) TV MONI. (VIDEO/S-VIDEO) output jacks

Connect the TV MONI jack to your TV's video input (VIDEO IN) jack. You can connect your video equipment with S-VIDEO jacks if possible, or the composite VIDEO jacks.

You must use the same type of connection from your video player into the receiver, and out of the receiver into your TV.

Both must be composite video or both must be S-Video. You cannot convert a signal from one type to the other.

### (8) SPEAKER SYSTEMS terminals

#### FRONT Left & Right speakers output terminals

Connect to the front left & right speakers.

#### CENTER speaker output terminals

Connect to the center speaker.

#### SURROUND Left & Right speakers output terminals

Connect to the surround (rear) left & right speakers.

#### SURROUND Center speaker output terminals

Connect to the surround center speaker.

### (9) 6.1 CH INPUT jacks

Connect to the outputs of DVD Audio player, SACD Multi channel player or an external multichannel decoder.

### (10) DIGITAL outputs

#### Optical and Coaxial

Connect to the digital input of your digital recording equipment.

### (11) DIGITAL inputs

#### Fig.1,2 (Optical) and Fig. 3, 4 (Coaxial)

Connect each input to the digital output of your source equipment. Use the SETUP MAIN MENU to assign digital input to appropriate source. (see page. 17)

#### Note :

- The coaxial connections are not for AC-3 RF from the LD player. If you want to decode this type of signal, an external demodulator must be used.

### (12) REMOTE CONTROL IN/OUT terminals

Connect to a Marantz component equipped with remote control (RC-5) terminals.

### (13) Analog AUDIO outputs for video recording equipment

#### VCR1, and DSS/VCR2

Connect each output to the audio inputs (REC in) of your video recording equipment.

### (14) Analog AUDIO inputs for video source equipment

#### TV, DVD, VCR1, and DSS/VCR2

Connect each input to the audio outputs of your video source equipment.

### (15) VIDEO inputs

#### TV, DVD, VCR1, and DSS/VCR2

Connect each input to the video outputs of your video source equipment.

### (16) S-VIDEO inputs

#### TV, DVD, VCR1, and DSS/VCR2

Connect each input to the S-video outputs of your video source equipment.

### (17) AC OUTLET

Connect the power cables of components such as a DVD or CD player to this outlet.

This provides power only when the SR5300 is turned on and is useful for components which you use every time you play your system.

#### Caution:

- In order to avoid potential turn-off thumps, anything plugged in here should be powered up BEFORE the SR5300 is turned on.
- The capacity of this AC outlet is 100W. Do not connect devices that consume electricity more than the capacity to this AC outlet. If total power consumption of connected devices exceeds the capacity, protection circuit shuts down the power supply.

### (18) AC IN

Connect to supplied AC cable, and connect to AC power outlet. SR5300 can be powered by 230V AC only.

# REMOTE CONTROL OPERATION

## OPERATION

The provided remote control unit is a universal remote controller. The **POWER** button [2], numeric buttons [9] and control buttons [12] are used in common across different input source components.

The input source controlled with the remote control unit changes when one of the input selector buttons [3] is pressed.

- Example: To select the DVD as the input source and play the DVD player.

Press the **DVD** button [3] twice within 2 seconds.

The input selector of the SR5300 is switched to DVD and the remote control unit is set for control of the DVD player. Press the **PLAY** button on the remote controller .

## FUNCTION AND OPERATION

### 1 Transmitting indicator

Lights up during a button is pressed and an infrared signal is sending.

### 2 (Main) POWER buttons

Press to switch the power of the SR5300 ON or OFF after pressing the **AMP** button [3].

### 3 Input selector buttons/ FUNCTION SELECTOR buttons (AUDIO/VIDEO INPUT)

Press one of these buttons once or twice to select a particular source component. For example, to set the receiver to the DVD input, press the **DVD** button twice within 2 seconds.

#### Note:

- **CDR/MD** button is set CDR function at initial. To switch MD function, press and hold down **CDR/MD** button and press **2** button [9].
- To return CDR function, press and hold down **CDR/MD** button and press **1** button [9].

### 4 MAIN VOLUME UP (▲) /DOWN (▼) buttons

Main volume control of the SR5300. The front, surround, center and subwoofer channel volumes controlled by these buttons simultaneously.

### 5 MUTE button

Muting button of the SR5300. Press this button decrease the sound temporarily . Press this button again to return to the previous sound.

### 6 MENU button

This button is used to enter the SETUP MAIN MENU.

### 7 Cursor buttons (◀, ▶, ▲, ▼, OK)

Use these button when operating the SETUP MAIN MENU. See page 16.

### 8 MENU OFF button

This button is used to exit from the SETUP MAIN MENU.

### 9 Numeric buttons 1 to 9 (A, B, C ... Z, -) / Surround mode buttons

#### Numeric buttons

These buttons are used to enter figures in the selection of a tuner preset station and station name preset or to set select a CD track number, etc. The functions of these buttons are dependent on the function button selected.

#### Surround mode buttons (when AMP mode is selected)

These buttons are used to select the surround mode.

### 10 P.SCAN (preset scan) button (when TUNER mode is selected)

This button is used to start preset scan when SR5300 is selected TUNER mode.

### 11 0 / A/D button

#### 0 button

This button is used to enter the number "0"

#### A/D button (when AMP mode is selected)

This is used to switch between the analog and digital inputs.

### 12 CONTROL buttons

These buttons are used when operating the CD player, TAPE deck, etc. The function of these buttons are dependent on the function button selected.

For the controllable functions of each input function, please refer to following table.

	TV	VCR	DVD	DSS	TUNER	CD	TAPE	CDR	MD
◀ CHANNEL/SKIP	CH-	PREV	PREV	CH-	CH-	PREV	PREV	PREV	PREV
▶ CHANNEL/SKIP	CH+	NEXT	NEXT	CH+	CH+	NEXT	NEXT	NEXT	NEXT
◀ TUNE/SEARCH	—	REWIND	REWIND	—	TUNING-	REWIND	REWIND	REWIND	REWIND
▶ TUNE/SEARCH	—	FF	FF	—	TUNING+	FF	FF	FF	FF
●	—	REC	—	—	—	—	REC	REC	REC
◀ MODE	—	—	—	—	MODE	—	DIRECTION	—	—
DISP./RDS	CH DISPLAY	PAUSE	PAUSE	CH DISPLAY	RDS DISPLAY	PAUSE	PAUSE	PAUSE	PAUSE
▶ F.DIRECT	—	PLAY	PLAY	—	FREQ. DIRECT	PLAY	PLAY	PLAY	PLAY
+A/ANT	VIDEO	TV/VCR	DISC+	DSS/VCR	—	DISC+	DECK A	—	—
-B/VCR	VIDEO	TV/VCR	DISC+	DSS/VCR	—	DISC-	DECK B	—	—
■ PTY	—	STOP	STOP	—	RDS PTY	STOP	STOP	STOP	STOP

### 13 ATT (attenuator) button

When the input signal is too high and the voice distorts even by throttling the SR5300 VOLUME control, turn on this function. "ATT" is indicated when this function is activated.

The input level is reduced. Attenuator is invalid for use with the output signal of "REC OUT".

### 14 TREBLE UP (▲) /DOWN (▼) buttons

These buttons are used to adjust the tone control of high frequency sound for left, center and right speaker.

### 15 BASS UP (▲) /DOWN (▼) buttons

These buttons are used to adjust the tone control of low frequency sound for left, center right and subwoofer speaker.

### 16 MEMO button

Memory enable button for various preset functions.

**17 CLEAR button**

This button is used to cancel for certain memory or programming operations.

**18 DIMMER button**

When this button is pressed once, the display is dimmed.

When this button is pressed twice, the display is turned off and the "DISPLAY OFF" indicator lights up.

Press this button again to turn on the display again.

**19 NIGHT button**

Pressing this button prevents the Dolby Digital signal from playback at a loud voice. This function reduces the voice by 1/3 to 1/4 at maximum. Thus, it eliminates the occurrence of an abruptly loud voice at night. However, the function is valid only for the case when the Dolby Digital signal is entered into OPTICAL or COAXIAL and data to compress the voice exists in the signal to be played back.

**20 S- ( Source) DIRECT button**

When this button is pressed, the tone control circuit is bypassed as well as Bass Management.

**21 SETUP / T.TONE button**

Test tone function is used for adjusting the balance between the volume levels of speaker channels. Press **AMP** button and press this button to enter the test tone mode.

**22 OSD button**

When this button is pressed, the current setting are displayed on the TV monitor.

**23 SLEEP (sleep timer) button**

This button is used for setting the sleep timer. It can be operated the same way as the button in unit.

**24 TV VOLUME UP (▲) /DOWN (▼) buttons**

These buttons increase or decrease TV's volume.

**PROGRAMMING THE REMOTE CONTROLLER**

The remote controller RC5300SR must be programmed to use the codes for your appliances of different brands. This is done by keying in a 4-digit code or by scanning the codes until the correct one is found. We recommend to using the 4-digit code. This mode is faster and more reliable. The code scanning method should be used only if you cannot find the code for one of your appliances. The codes are listed at the end of this book.

**Important:**

Use the remote control buttons for programming, not the buttons of the receiver or other appliances.

**PROGRAMMING WITH THE 4-DIGIT CODE**

1. Press and hold down the function button [3] for the appliance which should be controlled and press **SETUP** [21] until the indicator [1] blinks twice.
2. Press the 4-digit code for appliance (code table at the end of this book)
3. When the procedure is successful, the indicator will blink twice.

**Note:**

- If the indicator did not blink twice, then repeat steps 1 through 2 and try entering the same code again.

**SCANNING THE CODE TABLE**

1. Switch on the appliance which should be controlled.
2. Press and hold down the function button [3] for appliance which should be controlled and press **SETUP** [21] until the indicator [1] blinking twice.
3. Press the code **9 - 9 - 1**.  
The indicator will blink twice.
4. Aim the remote control at the appliance and slowly alternate between pressing **POWER** [2] and the function button [3] for the appliance.
5. Stop when the appliance turns off.
6. Press **SETUP** [21] once to lock in the code.

**CHECKING THE CODE**

1. Press and hold down the function button [3] for appliance which should be controlled and press **SETUP** [21] until the indicator [1] blinking twice.
2. Press the code **9 - 9 - 0**.  
The indicator will blink twice.
3. To view the code for first digit, press **1** once.  
Wait 3 seconds, count the indicator blinks (e.g. 3 blinks = 3) and write down the number.

**Note:**

If a code digit is "0", the indicator will not blink.

4. Repeat step 3 three more times for remaining digits. Use **2** for the second digit, **3** for the third digit, and **4** for the fourth digit.

Once you have found and the codes for your various appliances, you may want to write them down here.

- TV -----
- VCR -----
- DSS -----
- DVD -----
- CD -----
- TAPE -----
- CDR -----
- MD -----

## OPERATION OF REMOTE CONTROL UNIT

### REMOTE CONTROL

The distance between the transmitter of the remote control unit and the IR SENSOR of the SR5300 should be less than about 5 meters. If the transmitter is pointed to a direction other than the IR SENSOR or if there is an obstacle between them, remote control may not be possible.

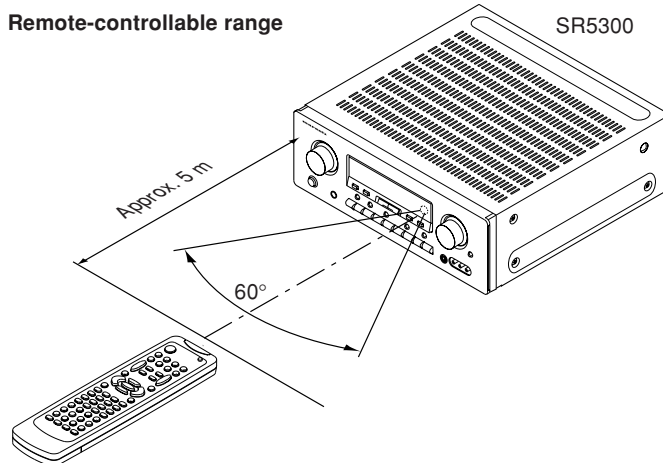

Remote control unit (RC5300SR)

### LOADING BATTERIES

The life of the batteries used with the remote control unit is about 4 months with normal use. Also be sure to replace batteries earlier when you notice that they are getting weak.

1. Remove the back cover.

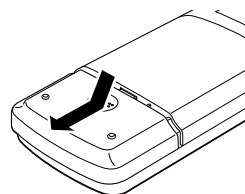

2. Insert the new batteries (AAA type) with correct (+) and (-) polarity.

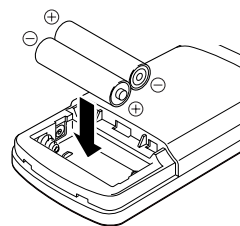

3. Close until it clicks.

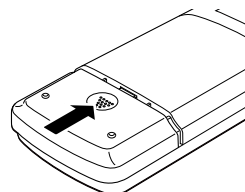

# CONNECTIONS

## SPEAKER PLACEMENT

The ideal surround speaker system for this unit is 7-speaker systems, using front left and right speakers, a center speaker, surround left and right speakers, a surround center and a subwoofer.

For best results we recommend that all front speakers be of the same type, with identical or similar driver units. This will deliver smooth pans across the front sound stage as the action moves from side to side.

Your center channel speaker is very important as over 80 % of the dialog from a typical motion picture emanates from the center channel. It should possess similar sonic characteristics to the main speakers. Surround channel speakers need not be identical to the front channel speakers, but they should be of high quality.

The surround center speaker is useful for playback of Dolby Digital Surround EX or DTS-ES. One of the benefits of both Dolby Digital (AC-3) and DTS is that surround channels are discrete full range, while they were frequency limited in earlier "Pro Logic" type systems. Bass effects are an important part of home theater. For optimal enjoyment a subwoofer should be used as it is optimized for low frequency reproduction. If you have full range front speakers, however, they may be used in place of a subwoofer with proper setting of the switches in the menu system.

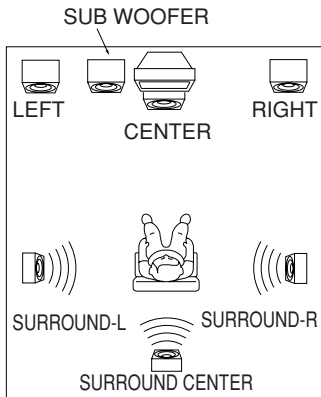

### Front left and right speakers

We recommend to set the front L and R speakers with 45-60 degrees from the listening position.

### Center speaker

Align the front line of the center speaker with the front L/R speakers. Or place the center speaker a little backward from the line.

### Surround left and right speakers

Place the speakers right beside of the listening position or a little forward. Do not place the speakers backward of the listening position.

### Surround center speaker

Place the speaker right behind of the listening position.

### Subwoofer

We recommend to use a sub-woofer to have maximum bass effect. Sub-woofer bears only low frequency range so you can place it anywhere in the room.

## HEIGHT OF THE SPEAKER UNITS

### Front left and right speakers, and a center speaker

Align the tweeters and mid-range drivers on the three front speakers on the same height as well as possible.

### Surround left and right speakers, and surround center speaker

Place the surround left, right and surround center speakers higher to your ears (70cm – 1m). Also place the speakers on the same height.

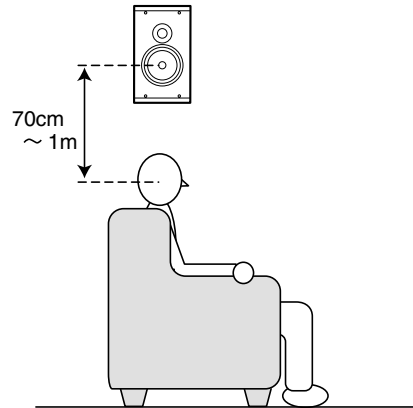

### Note;

- Use magnetically-shielded speakers for front left, right and the center speakers when the speakers are installed near the TV and the TV is a monitor type.



## CONNECTING SPEAKERS

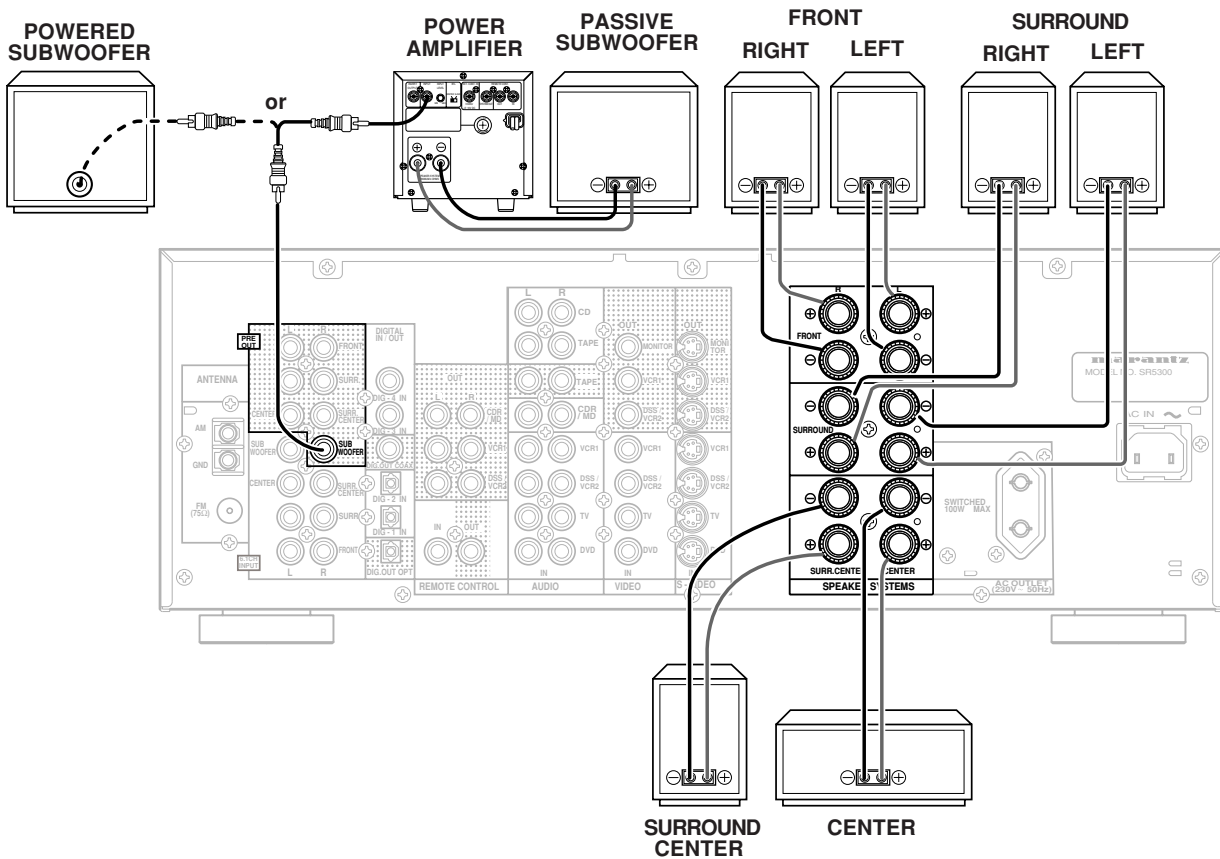

### CONNECTING SPEAKER WIRE

1. Strip away approx. 10 mm of wire insulation.
2. Twist the bared wire ends tight to prevent short circuits.
3. Loosen the knob by turning counterclockwise.
4. Insert the bare part of the wire into the hole in the side of each terminal.
5. Tighten the knob by turning clockwise to secure the wire.

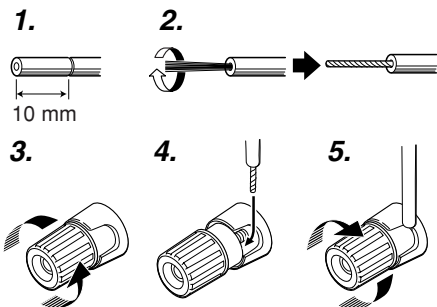

### CAUTION

- Be sure to use speakers with the specified impedance shown on the rear panel of this unit.
- To prevent damage to circuitry, do not let the bare speaker wires touch each other and do not let them touch any metal part of this unit.
- Do not touch the speaker terminals when the power is on. It may cause electric shocks.
- Do not connect more than one speaker cable to one speaker terminal. Doing so may damage this unit.

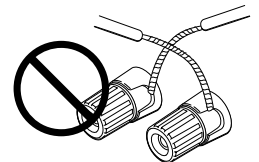

### NOTE

- Be sure to connect the positive and negative cables for the speaker properly. If they are miss-connected, the signal phase will be reversed and the signal quality will be corrupted.

### CONNECTING A SUBWOOFER

Use the PRE OUT SUBWOOFER jack to connect a powered subwoofer (power amplifier built in). If your subwoofer is passive type (power amplifier is not built in), connect a monaural power amplifier to the PRE OUT SUBWOOFER jack and connect the subwoofer to the amplifier.



CONNECTING AUDIO COMPONENTS

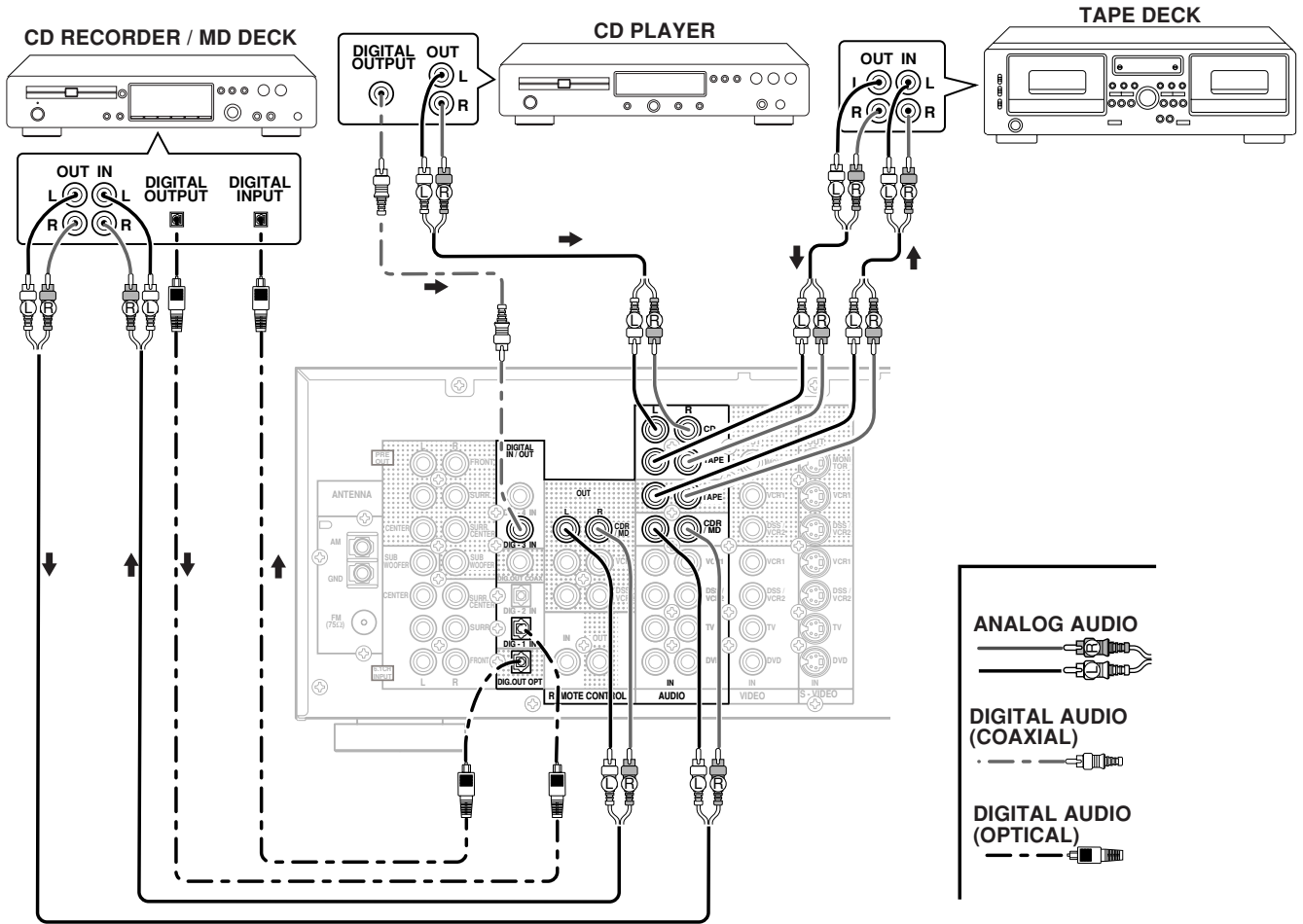

The output audio signal from the TAPE OUT jack and the CD-R/MD OUT jack is the sound source currently selected.

**CAUTION**

- Do not connect this unit and other components to mains power until all connections between components have been completed.

**NOTES**

- Insert all plugs and connectors securely. Incomplete connections may make noise.
- Be sure to connect the left and right channels properly. Red connectors are for the R(right) channel, and white connectors are for the L(left) channel.
- Be sure to connect input and output properly.
- Refer to the instructions for each component that is connected with this unit.
- Do not bind audio/video connection cables with power cords and speaker cables will result in generating hum or other noise.

**CONNECTING DIGITAL AUDIO COMPONENTS**

- There are four digital inputs, two coaxial jacks and two optical jacks, on the rear panel. You can use these jacks to input PCM, Dolby Digital and DTS bitstream signals from a CD, DVD, or other digital source components.
- There are one digital input with coaxial jack and one with optical jack on the rear panel. These jacks can be connected to CD recorder, MD deck.
- Setup the digital audio format of DVD player, or other digital source component. Refer to the instructions for each component to be connected to digital input jacks.
- Use fiber optical cables(optical) for DIG-1,2 input jacks. Use 75 ohms coaxial cables(for digital audio or video : optical) for DIG-3,4 input jacks.
- You can designate the input for each digital input/output jacks according to your component. See page 17.

**NOTES**

- There is no Dolby Digital RF input jack. Please use an external RF demodulator Dolby Digital decoder when connecting the Dolby Digital RF output jack of the video disc player to the digital input jack.
- The digital signal jacks on this unit conform to the EIA standard. If you use a cable that does not conform to this standard, this unit may not function properly.
- Each type of audio jack works independently. Signals input through the digital and analog jacks are output through the corresponding digital and analog jacks, respectively.

## CONNECTING VIDEO COMPONENTS

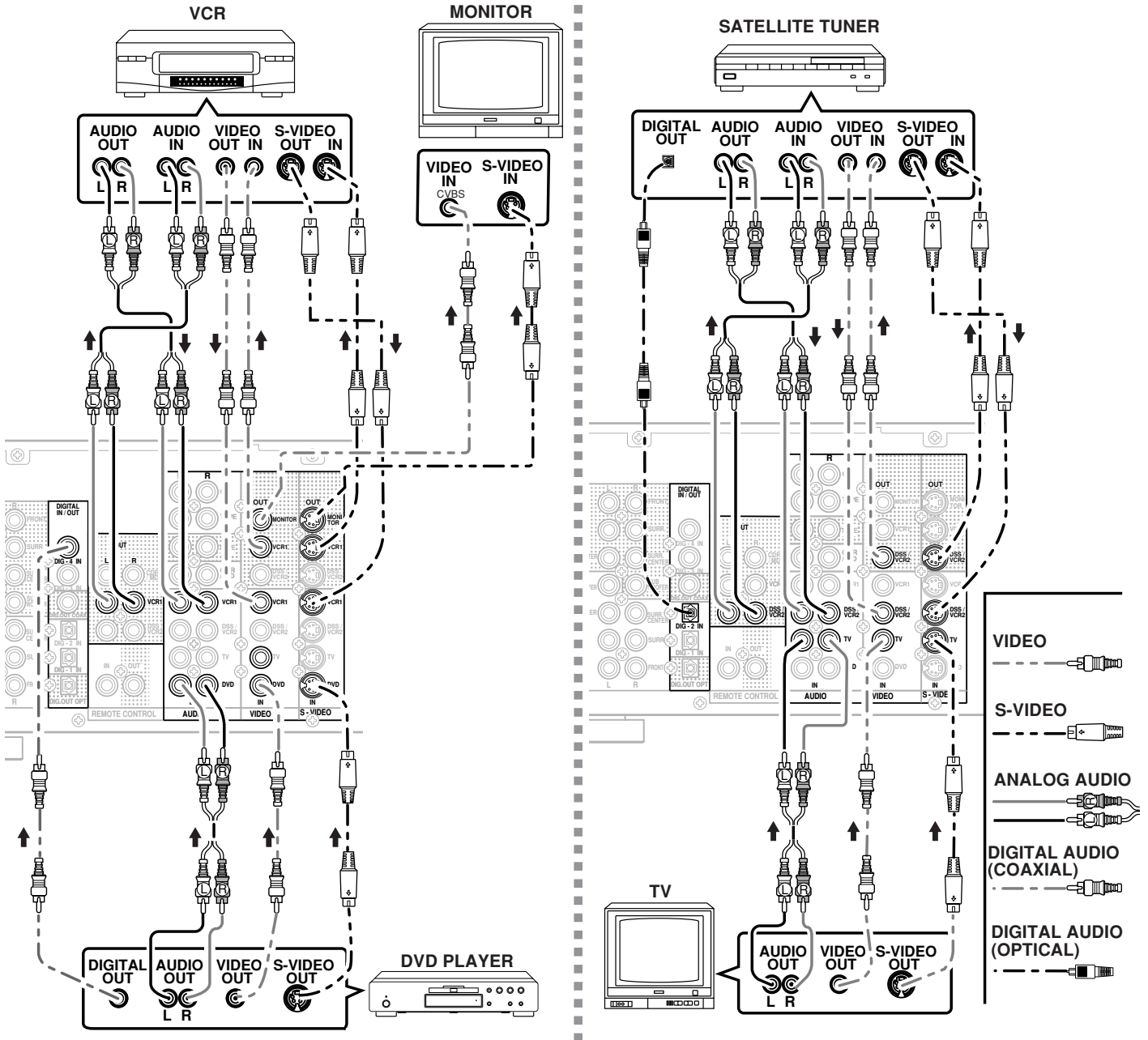

### VIDEO, S-VIDEO JACKS

There are two types of video jacks on the rear panel.

#### VIDEO jack

The video signal for the VIDEO jacks is the conventional composite video signal.

#### S-VIDEO jack

The video signal is separated into luminance(Y) and color(C) signals for the S-VIDEO jack. The S-VIDEO signals enables high-quality color reproduction. If your video component has an S-VIDEO output, we recommend to use it. Connect the S-VIDEO output jack on your video component to the S-VIDEO input jack on this unit.

#### NOTES

- Be sure to connect the left and right audio channels properly.  
Red connectors are for the R(right) channel, and white connectors are the for L(left) channel.
- Be sure to connect input and output of video signal properly.

- If you connect the S-VIDEO signal to the S-VIDEO jack on this unit, it is not necessary to connect the conventional video signal to the VIDEO(composite) jack. If you use both video inputs, this unit gives priority to the S-VIDEO signal.
- Each type of video jack works independently. Signals input to the VIDEO(composite) and S-VIDEO jacks are output to the corresponding VIDEO(composite) and S-VIDEO jacks, respectively.
- This unit has the "TV-AUTO ON/OFF" function to turn ON or OFF automatically the power by the incoming video signal from VIDEO jacks.
- You may need to setup the digital audio output format of your DVD player, or other digital source component. Refer to the instructions of the each component connected to the digital input jacks.
- There is no Dolby Digital RF input jack. Please use an external RF demodulator with Dolby Digital decoder to connect a video disc player with the Dolby Digital RF output jack to the digital input jack on this unit.

**ADVANCED CONNECTING**

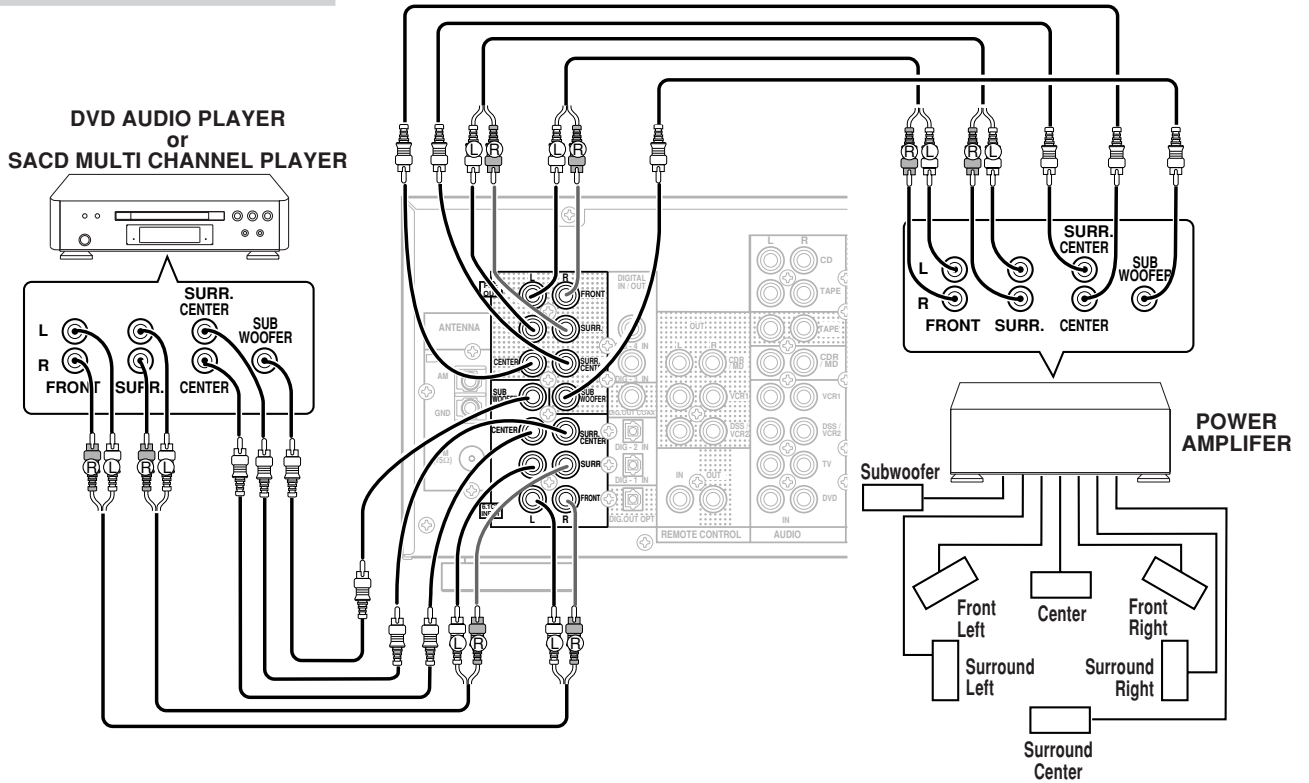

**CONNECTING MULTI CHANNEL AUDIO SOURCE**

The 6.1CH INPUT jacks are for multi channel audio source such as SACD multi channel player, DVD audio player or external decoder. If you use these jacks, switch on 6.1CH INPUT and setup 6.1CH INPUT level by using SETUP MAIN MENU. See page 20.

**CONNECTING EXTERNAL POWER AMPLIFIER**

The PREOUT jacks are for connecting external power amplifiers, you can have better sound quality. Be sure to connect each speaker to the corresponding external power amplifier.

**CONNECTING REMOTE CONTROL JACKS**

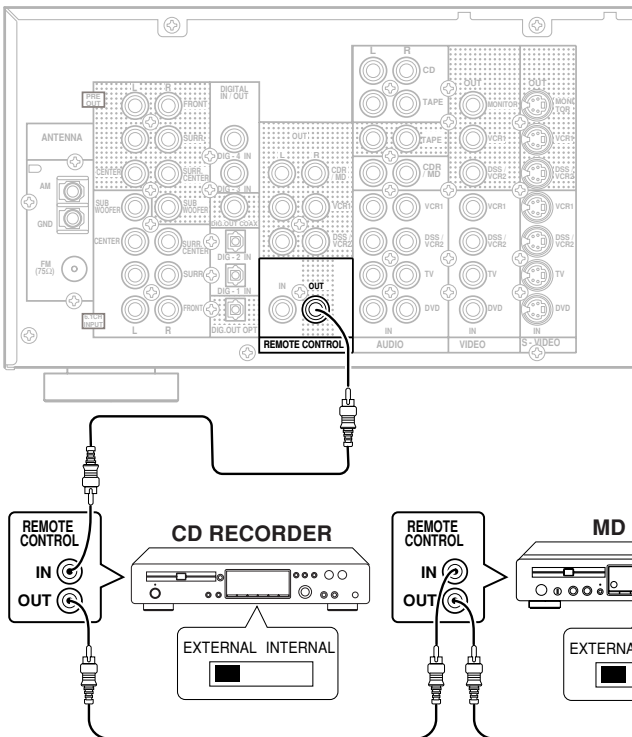

You can control other Marantz products through this unit with the remote controller by connecting REMOTE CONTROL terminals on each unit.

The signal transmitted from the remote controller is received by the remote sensor on this unit then the signal is sent to the connected device through this terminal. Therefore you need to aim the remote signal only to the unit. Also, if a Marantz power amplifier (some models excluded) is connected with this terminal, the power amplifier's power switch is synchronized with this unit's power switch.

Set the REMOTE CONTROL SWITCH on the units other than this unit to EXT.(EXTERNAL) for this feature.

## CONNECTING THE ANTENNA TERMINALS

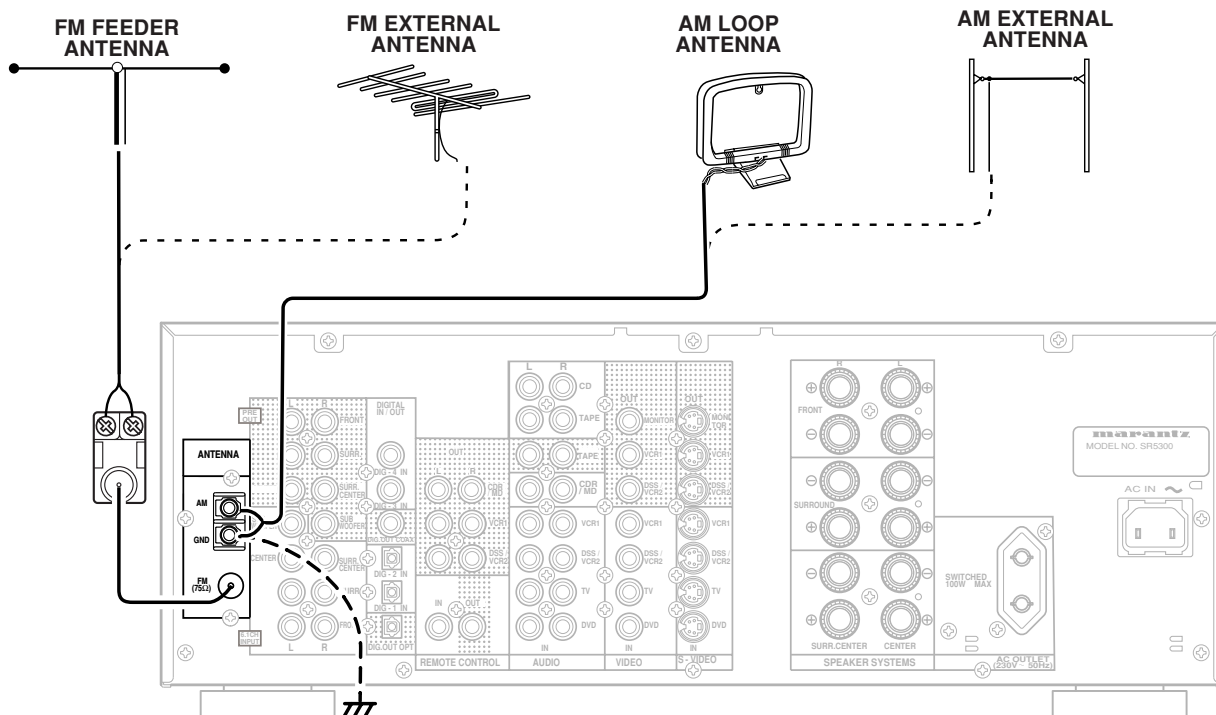

### ASSEMBLING THE AM LOOP ANTENNA

1. Release the vinyl tie and take out the connection line.
2. Bend in the reverse direction.
3. Inserting into the hole to attach the loop antenna to the antenna stand.
4. With the antenna on top any stable surface.

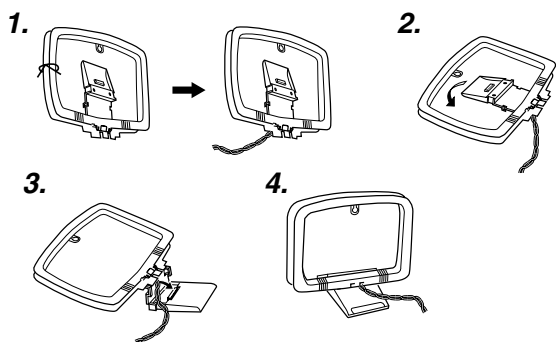

### CONNECTING THE ANTENNA CABLE TO THE 75/300 Ω ANTENNA ADAPTER

#### Connecting the 300 Ω ribbon wire

Loosen the screws and wrap the wire around these screws. Then tighten the screws with a screwdriver.

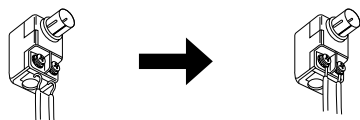

### CONNECTING THE SUPPLIED ANTENNAS

#### Connecting the supplied FM feeder antenna

The supplied FM feeder antenna is for indoor use only. During use, extend the antenna and move it in various directions until the clearest signal is received. Fix it with push pins or similar implements in the position that will cause the least amount of distortion. If you experience poor reception quality, an outdoor antenna may improve the quality.

#### Connecting the supplied AM loop antenna

The supplied AM loop antenna is for indoor use only. Set it in the direction and position where you receive the clearest sound. Put it as far away as possible from the unit, televisions, speaker cables, and power cords. If you experience poor reception quality, an outdoor antenna may improve the quality.

1. Loosen the AM antenna terminal screw counterclockwise.
2. Insert the bared wire into the antenna terminal.
3. Tighten the screw by turning clockwise to secure the wire

### CONNECTING AN FM OUTDOOR ANTENNA

#### NOTES

- Keep the antenna away from noise sources (neon signs, busy roads, etc.).
- Do not put the antenna close to power lines. Keep it well away from power lines, transformers, etc.
- To avoid the risk of lightning and electrical shock, grounding is necessary.

### CONNECTING AN AM OUTDOOR ANTENNA

An outdoor antenna will be more effective if it is stretched horizontally above a window or outside.

#### NOTES

- Do not remove the AM loop antenna.
- To avoid the risk of lightning and electrical shock, grounding is necessary.

# SETUP

After all components are connected, initial setup must be performed.

## ON SCREEN DISPLAY MENU SYSTEM

The SR5300 incorporates an on-screen menu system, which makes various operations possible by using the cursor (▲, ▼, ◀, ▶) and OK buttons on the remote control unit.

**Notes:**

- To view the on-screen displays, make certain you have made a connection from the Monitor Out jack (VIDEO or S-VIDEO) on the rear panel to the composite, S-Video input of your TV or projector. (see page 13)
- In order to view the SR5300's displays, the correct video source must be selected on the video display.

1. Select the **AMP** mode in remote controller.
2. Press **MENU** button on the remote controller to display the "SETUP MAIN MENU" of the OSD menu system. There are 7 items in the SETUP MAIN MENU.
3. Select a desired sub-menu with ▲ or ▼ cursor button, and press the **OK** button to entry.

The display will change to selected sub-menu.

You can lock the condition of setup to each sub-menu with ◀ or ▶ cursor buttons.

**Notes:** If you desire to adjust any sub-menu, you need to set UNLOCK.

4. If you desire to exit from this menu system, press **MENU OFF** button or move the cursor to **EXIT** and press the **OK** button.

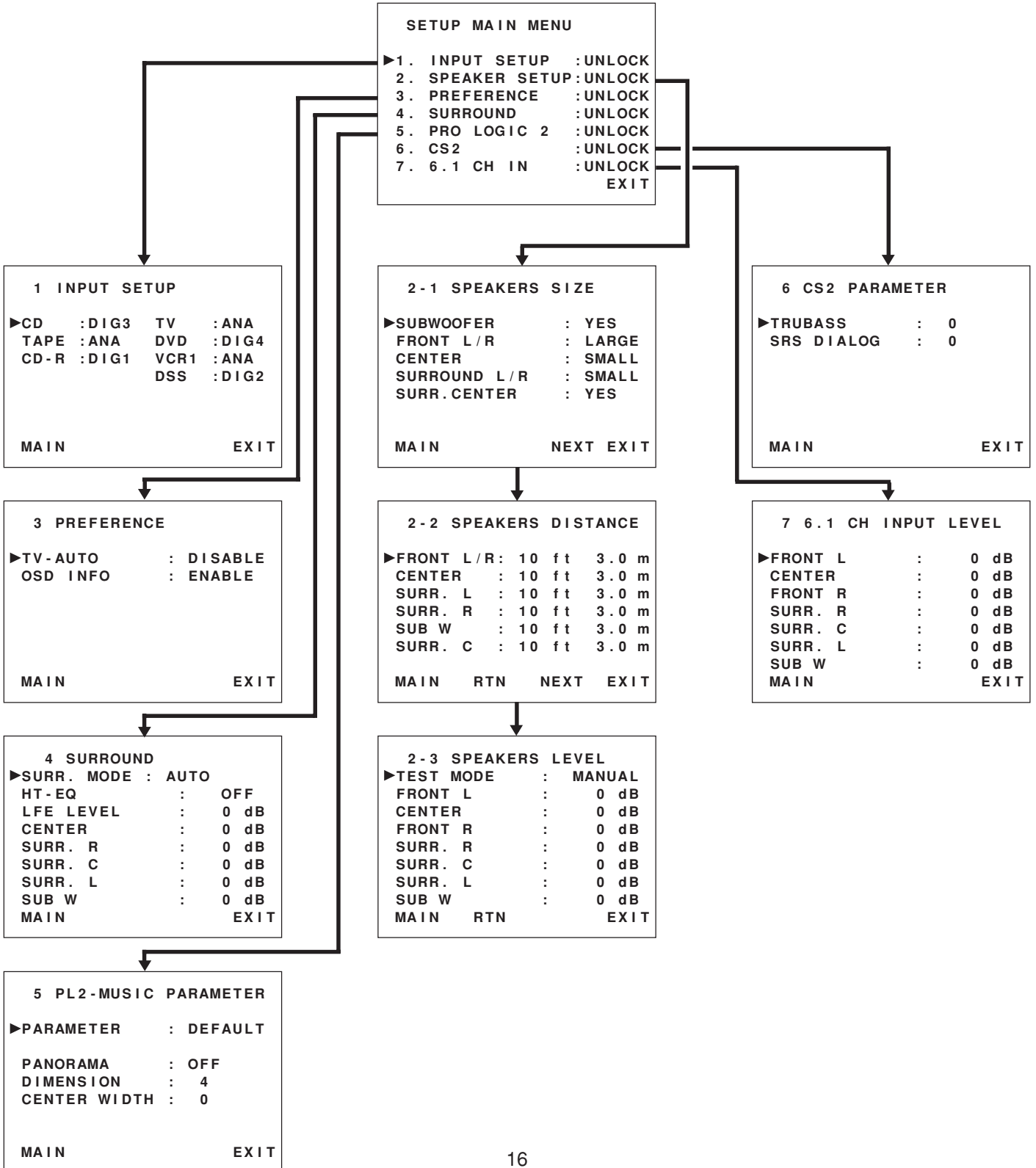

## INPUT SETUP (ASSIGNABLE DIGITAL INPUT)

Four digital inputs can be assigned as the desired source. Use this menu to select the digital input jack to be assigned to the input source.

1. Select "INPUT SETUP" in SETUP MAIN MENU with ▲ or ▼ cursor button, and press the OK button.

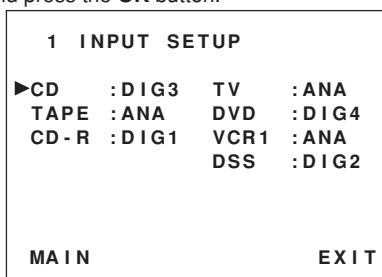

2. To select the input source, press ▲ or ▼ cursor button.
3. To select the digital input jack, press ◀ or ▶ cursor buttons. Select "Dig x" for input sources, for fixed the digital input jack. Select "ANA" for input sources for which no digital input jacks are used.
4. If you finish the setup in this sub-menu, move cursor to MAIN with ▲ or ▼ cursor buttons and press OK button.

**Notes:**

- The TUNER and AUX are fixed to the analog input, and cannot be selected for any digital input.
- When a DTS-LD or DTS-CD is playing, this setup is not available. This is to avoid noise being generated from the analog input.

## SPEAKER SETUP

After you have installed the SR5300, connected all the components, and determined the speaker layout, it is now time to perform the settings in the Speaker Setup menu for the optimum sound acoustics for your environment and speaker layout. Before you perform the following settings, it is important that you first determine the following characteristics:

### SPEAKER SIZE

When setting the speaker size in the SPEAKER SIZE sub-menu, use the guidelines given below.

**LARGE:** The complete frequency range for the channel you are setting will be output from the speaker.

**SMALL:** Frequencies of the channel you are setting lower than 100 Hz will be output from the subwoofer.

If the Subwoofer is set to "NONE" and the front speakers are set to "LARGE," then the sound may be output from both the left and right speakers.

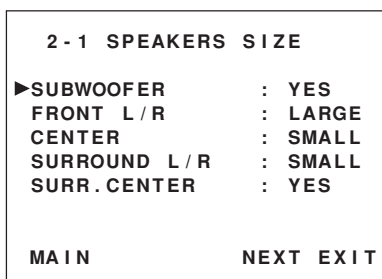

1. Select "SPEAKER SETUP" in MAIN SETUP MENU with ▲ or ▼ cursor button, and press the OK button.
2. To select the each speaker, press ▲ or ▼ cursor button.

3. To select the setting of size to each speaker, press ◀ or ▶ cursor buttons.
4. If you finish these setup, move cursor to "NEXT" with ▲ or ▼ cursor button and then press OK button to go to next page.

**SUBWOOFER:**

**YES:** Select when a subwoofer is connected.

**NONE:** Select when a subwoofer is not connected.

**FRONT L/R**

**LARGE:** Select if the front speakers are large sized.

**SMALL:** Select if the front speakers are small sized.

- If "NONE" is selected for the Subwoofer setting, then this setting is fixed to "LARGE."

**CENTER**

**NONE:** Select if no center speaker is connected.

**LARGE:** Select if the center speaker is large sized.

**SMALL:** Select if the center speaker is small sized.

**SURROUND L/R**

**NONE:** Select if no surround left and right speakers are connected.

**LARGE:** Select if the surround left and right speakers are large sized.

**SMALL:** Select if the surround left and right speakers are small sized.

**SURR. CENTER**

**YES:** Select when a surround center is connected.

**NONE:** Select when a surround center is not connected.

- If "NONE" is selected for the Surround L/R setting, then this setting is not available.



## SPEAKER DISTANCE (TIME ALIGNMENT)

Use this parameter to specify the distance of each speaker's position from the listening position. The delay time is automatically calculated according to these distances.

Begin by determining the ideal or most commonly used seating position in the room.

This is important for the timing of the acoustics to create the proper sound space that the SR5300 and today's sound systems are able to produce.

Note that the speakers that you selected "NONE" for in the Speaker Config sub-menu will not appear here.

(There are several useful books and special DVD and LD's available to guide you through proper home theater configuration. If you are unsure, have your Marantz dealer perform the installation for you.

They are trained professionals familiar with even the most sophisticated custom installations.)

2 - 2 SPEAKERS DISTANCE			
▶FRONT L / R :	10 ft	3.0 m	
CENTER :	10 ft	3.0 m	
SURR. L :	10 ft	3.0 m	
SURR. R :	10 ft	3.0 m	
SUB W :	10 ft	3.0 m	
SURR. C :	10 ft	3.0 m	
MAIN	RTN	NEXT	EXIT

- To select the each speaker , press ▲ or ▼ cursor button.
- To set the distance for each speaker , press the ◀ or ▶ cursor buttons.
- If you finish these setup, move cursor to "NEXT" with ▲ or ▼ cursor button and then press OK button to go to next page.

**FRONT L/R :** Set the distance from the front left/right speaker to your normal listening position between 1 and 30 feet in 1.0 foot interval (0.3 to 9 meters in 0.3-meter intervals).

**CENTER :** Set the distance from the center speaker to your normal listening position between 1 and 30 feet in 1.0 foot interval (0.3 to 9 meters in 0.3-meter intervals).

**SURR. L :** Set the distance from the surround left speaker to your normal listening position between 1 and 30 feet in 1.0 foot interval (0.3 to 9 meters in 0.3-meter intervals).

**SURR. R :** Set the distance from the surround right speaker to your normal listening position between 1 and 30 feet in 1.0 foot interval (0.3 to 9 meters in 0.3-meter intervals).

**SUB W :** Set the distance from the subwoofer to your normal listening position between 1 and 30 feet in 1.0-foot intervals (0.3 to 9 meters in 0.3-meter intervals).

**SURR. C :** Set the distance from a surround center speaker to your normal listening position between 1 and 30 feet in 1.0-foot intervals (0.3 to 9 meters in 0.3-meter intervals).

### Notes

- Speakers that you selected "NONE" for in the Speaker Size menu will not appear.

## SPEAKERS LEVEL

Here you will set the volume for each speaker so that they are all heard by the listener at the same level.

### Note:

- The speaker level settings is not available in 6.1channel input mode and S-Direct mode.

2 - 3 SPEAKERS LEVEL		
▶TEST MODE :	MANUAL	
FRONT L :	0 dB	
CENTER :	0 dB	
FRONT R :	0 dB	
SURR. R :	0 dB	
SURR. C :	0 dB	
SURR. L :	0 dB	
SUB W :	0 dB	
MAIN	RTN	EXIT

**TEST MODE :** Selects "MANUAL" or "AUTO" for generating mode of test tone ◀ or ▶ cursor button.

If you select "AUTO", the test tone will be cycled through in a circular pattern which is Left → Center → Right → Surround Right → Surround Center → Surround Left → Subwoofer → Left →.. increments of 2 seconds for each channel.

Using the ◀ and ▶ cursor buttons, adjust the volume level of the noise from the speaker so that it is the same level for all speaker.

If you select "MANUAL", adjust the output level of each speaker as follows.

- When you move cursor to FRONT L by pressing ▼ cursor button, the SR5300 will emit a pink noise from the front left speaker.  
At this time, the master volume automatically increases to the reference level (0 dB).  
Remember the level of this noise and then press the ▼ cursor button.  
(Note that this can be adjusted to any level between -10 and +10 dB in 1 dB intervals).  
The SR5300 will now emit the pink noise from the center speaker.
- Using the ◀ and ▶ cursor buttons, adjust the volume level of the noise from the center speaker so that it is the same level as the front left speaker.
- Press the ▼ cursor button again. The SR5300 will now emit the pink noise from the front right speaker.
- Repeat steps 2 and 3 above for the front right and other speakers until all speakers are adjusted to the same volume level.

If you finish these setup, press OK button, the cursor will move to "MAIN" and then press OK button to go to SETUP MAIN MENU.

### Notes:

- Speakers that you selected "NONE" for in the Speaker Size menu will not appear.
- The setup level for each channel is memorized for reproduction in all surround mode.
- To adjust the speaker levels for 6.1-channel input sources, you will need to use the 6.1CH-INPUT sub menu. (See page 20).
- In order to correctly set the output levels, use a hand-held Sound Pressure Level meter (SPL), set to C-Weighting and Slow averaging. A Radio Shack® SPL meter (catalogue number 330 - 2055) works well. Using the internal channel noise generators, set each channel so that you read 75 dB SPL from each channel when seated at the listening position.



## PREFERENCE

3 PREFERENCE	
▶TV - AUTO	: DISABLE
OSD INFO	: ENABLE
MAIN	EXIT

1. Select "PREFERENCE" in SETUP MAIN MENU with ▲ or ▼ cursor button, and press the **OK** button.
2. To select a desired content, press ▲ or ▼ cursor button.

**TV AUTO:** Select the TV AUTO ON/OFF function to enable or disable with ◀ or ▶ cursor button.  
(refer to page 23)

**OSD INFO:** Select the OSD information function to enable or disable with ◀ or ▶ cursor button.

If you select "ENABLE", SR5300 will display the status of the feature (Volume up/down, input select, etc..) on the TV monitor. But if you do not desire this information, select "DISABLE".

If you finish the setup in this item, move cursor to "MAIN" with ▲ or ▼ cursor buttons and press **OK** button.

## SURROUND

4 SURROUND	
▶SURR. MODE	: AUTO
HT - EQ	: OFF
LFE LEVEL	: 0 dB
CENTER	: 0 dB
SURR. R	: 0 dB
SURR. C	: 0 dB
SURR. L	: 0 dB
SUB W	: 0 dB
MAIN	EXIT

1. Select "SURROUND" in SETUP MAIN MENU with ▲ or ▼ cursor button, and press the **OK** button.
2. To select a desired content, press ▲ or ▼ cursor button.

**SURR-MODE:** Select the desired surround mode with ◀ or ▶ cursor button.

**HT-EQ:** Select to activate the HT (Home Theater)-EQ with ◀ or ▶ cursor button.

This mode compensates for the audio portion of a movie sounding "bright".

This equalizer is effective in Auto, DOLBY, DTS and SEREO mode.

**LFE LEVEL:** Select the output level of the LFE signal included in the Dolby Digital signal or the DTS signal.

Select 0dB, -10 dB or OFF with ◀ or ▶ cursor button. The level is ordinarily set to 0 dB except DTS-Music mode. In the DTS-Music mode, default level is set to -10 dB.

**CENTER:** Adjust the volume level of the center speaker between -10 dB and +10 dB in 1 level interval with ◀ or ▶ cursor button.

**SURR. R:** Adjust the volume level of the surround right speaker between -10 dB and +10 dB in 1 level interval with ◀ or ▶ cursor button.

**SURR. C:** Adjust the volume level of the surround center speaker between -10 dB and +10 dB in 1 level interval with ◀ or ▶ cursor button.

**SURR. L:** Adjust the volume level of the surround left speaker between -10 dB and +10 dB in 1 level interval with ◀ or ▶ cursor button.

**SUB W:** Adjust the volume level of the subwoofer speaker between -10 dB and +10 dB in 1 level interval with ◀ or ▶ cursor button.

If you finish the setup in this item, move cursor to "MAIN" with ▲ or ▼ cursor buttons and press **OK** button.

### Note:

- CENTER, SURR.R, SURR. C, SURR. L, and SUB W volume level are synchronized with SETUP MAIN MENU 2-3 Speaker Level.

## PL2 (PRO LOGIC II) MUSIC PARAMETER

Pro Logic II-Music mode creates a rich and enveloping surround ambience from stereo sources such as CDs.

In this mode, SR5300 includes three controls to fine-tune the soundfield as follow.

5 PL2-MUSIC PARAMETER	
▶PARAMETER	: DEFAULT
PANORAMA	: OFF
DIMENSION	: 4
CENTER WIDTH	: 0
MAIN	EXIT

Select "PRO LOGIC 2" in SETUP MAIN MENU with ▲ or ▼ cursor button, and press the **OK** button.

**PARAMETER:** Select "DEFAULT" or "CUSTOM" with ◀ or ▶ cursor button

If you select "CUSTOM", you can adjust three parameters as follow

**PANORAMA:** Select the Panorama mode On or Off with ◀ or ▶ cursor button.

Panorama wraps the sound of the front left and right speakers around you for an exciting perspective.

**DIMENSION:** Set the Dimension level between 0 and 6 level in 1 level interval with ◀ or ▶ cursor button.

Adjust the soundfield either towards the front or towards the rear.

This can be useful to help achieve a more suitable balance from all the speakers with certain recordings.

**CENTER WIDTH:** Set the Center width level between 0 and 7 level in 1 level interval with ◀ or ▶ cursor button.

Center Width allows you to gradually spread the center channel sound into the front left and right speakers.

At its widest setting, all the sound from the center is mixed into the left and right.

This control may help achieve a more spacious sound or a better blend of the front image.

If "NONE" was selected for the Center speaker setting in the Speaker size, then this setting will not appear.

If you finish the setup in this menu, move cursor to "MAIN" with ▲ or ▼ cursor buttons and press **OK** button.

## CS2 (CIRCLE SURROUND II) PARAMETER

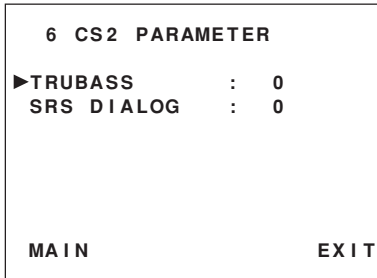

1. Select "CS2" in SETUP MAIN MENU with ▲ or ▼ cursor button, and press the **OK** button.
2. To Select desired contents as below, press ▲ or ▼ cursor button
  - TRUBASS:** Set the TRUBASS level between 0 and 6 level in 1 level interval with ◀ or ▶ cursor button. TRUBASS produced by the speakers to be an octave below the actual physical capabilities of the speakers adding exciting, deeper bass effects.
  - SRS DIALOG:** Set the SRS DIALOG level between 0 and 6 level in 1 level interval with ◀ or ▶ cursor button. This can be popped out of the surround audio effects allowing the listener to easily discern what the actors say. If "NONE" was selected for the Center speaker setting in the Speaker size, then this setting will not appear.

If you finish the setup in this menu, move cursor to "MAIN" with ▲ or ▼ cursor buttons and press **OK** button.

## 6.1 CH INPUT LEVEL

This sub-menu is to adjust the speaker levels for 6.1-channel input sources.

Here you will adjust the volume for each channel so that they are all heard by the listener at the same level.

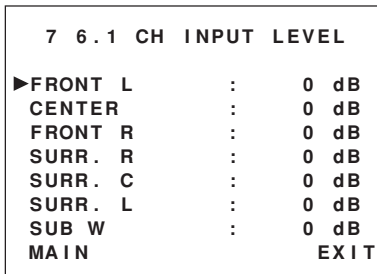

1. Select "6.1CH IN" in SETUP MAIN MENU with ▲ or ▼ cursor button, and press the **OK** button.
2. To Select desired channel , press ▲ or ▼ cursor button.
3. Using the ◀ or ▶ cursor buttons, adjust the volume level of each channel.
4. If you finish the setup in this menu, move cursor to "MAIN" with ▲ or ▼ cursor buttons and press **OK** button.

### Note:

- The condition of these setup will be memorized to 6.1CH INPUT source.

# BASIC OPERATION

## LISTENING TO THE TUNER

### MANUAL TUNING

1. To select the tuner as the source, press the **TUNER** button ⑤ on the front panel or press the **TUNER** button ③ on the remote.
2. Press the **TUNER** button ⑤ on the front panel or press the **TUNER** button ③ on the remote to select the desired frequency band if required.
3. Press the **F/P** button ⑮ on the front panel to display the frequency.
4. Press the **TUNING/PRESET ▲** or **▼** button ⑭ on the front panel or press the **◀◀** or **▶▶** button ⑫ on the remote.
5. If FM is selected, press the **MODE** button ⑯ on the front panel or press the **MODE** button ⑫ on the remote control to select the desired audio mode.

### (FM) MODE BUTTON OPERATION

When "AUTO" indicator is on in the display, FM stations that broadcast in stereo will be received in stereo and the "STEREO" indicator lights.

When "AUTO" indicator is off, all the FM stations will be received in mono regardless of whether or not they are broadcasting in stereo.

### AUTO TUNING (USING THE SR5300)

1. Press the **F/P** button ⑮ on the front panel to display the frequency.
2. Press the **TUNING/PRESET ▲** or **▼** button ⑭ on the front panel for more than 1 second to start the Auto tuning function.

### AUTO TUNING (USING THE REMOTE CONTROL UNIT)

Press **◀◀** or **▶▶** button ⑫ for more than 1 second to start the Auto tuning function.

### PRESET TUNING

With this unit you can preset up to 30 FM/AM stations in any order. For each station, you can memorize the frequency and reception mode if desired.

#### 1-a. Manual Presetting (Using the SR5300)

1. Refer to the "MANUAL TUNING" or "AUTO TUNING" section above to tune in a desired station.
2. Press the **MEMORY** button ⑬. "MEMO" indicator starts blinking on the display.  
While "MEMO" is still blinking (approx. 5 seconds), select the preset number by pressing the **TUNING/PRESET ▲** or **▼** button ⑭ then press the **MEMORY** button ⑬ again.
3. When a number has been properly input, "MEMO" indicator stops blinking and goes out.  
The station is now stored in the specified preset memory location.

#### 1-b. Manual Presetting (Using the remote control unit)

1. Tune in a desired station.
2. Press the **MEMO** button ⑬.
3. Enter the desired preset number with ten keypad ⑨.
4. Then, press **MEMO** button ⑬ again to store.

#### 2. Auto Presetting

This function automatically scans the AM and FM band and enters all stations with sufficient signal strength into the memory.

1. Press and hold down the **MEMORY** button ⑬ and **TUNER** button ⑤ simultaneously, auto presetting will start.
2. "MEMO" will blink on the display.
3. Each time the tuner finds a station, the scanning will pause and memory. Auto presetting will start.
4. Operation stops automatically when all 30 preset memory positions are filled or when auto scanning attains the highest end of all bands.  
To stop the auto preset function at anytime, press the **CLEAR** button ⑫.

#### 3. Recalling a Preset Station

1. Press the **F/P** button ⑮ to change the display to preset.
2. Select the desired preset station by pressing **TUNING/PRESET ▲** or **▼** button ⑭ on the front panel or press **CHANNEL** button ⑫ on the remote.

#### Note:

- To directly access the preset stations using the numeric keypad, select the desired preset station by entering one or two digits using the numeric keypad ⑨.
- To return to the Manual Tuning mode, press the **F/P** button ⑮.

#### 4. Preset Scan Tuning (Using the remote control unit)

1. Press the **P.SCAN** button ⑩ on the remote control. (The preset station with the smallest preset number is recalled first. If no stations have been preset, "NO PRESET" shows in the display and the unit returns to the previous mode.)
2. Preset stations are recalled in sequence (CH-1 → CH-2, etc.) for 5 seconds each. Preset numbers that do not contain stations are skipped.
3. You can fast forward the preset stations by pressing the **CHANNEL ▶▶** button ⑫ continuously.  
When the desired preset station is received, cancel the preset scan operation by pressing the **CHANNEL ◀◀** button ⑫ or the **CLEAR** button ⑫.

#### 5. Clearing Preset Stations

You can remove preset stations from memory using the following procedure.

1. Recall the preset number to be cleared with the method described in "Recalling" a preset station .
2. Press the **CLEAR** button ⑫ on the front panel or **CLEAR** button ⑫ on the remote control unit for 3 seconds or more.  
"CLEAR" appears on the display to indicate that the specified preset number has been cleared.

#### 6. Frequency Direct Call

1. Press **F.DIRECT** button ⑫ in the TUNER mode on the remote controller.
2. Display shows "FM- --. --. --MHz" (at FM mode).
3. Input your desired frequency with tenkeypad buttons on the remote controller.  
Eg) 98.1 MHz  
Press **9, 8, 1** and **0**
4. Display fixed 98.10 MHz and broadcast station received.

**STATION NAME PRESET (On PRESET display mode)**

The station name preset function allows the name of each preset channel to be entered using alphanumeric characters. The Station Name button is valid only in the tuner mode. Before station name preset operation, store stations with the preset memory operation.

1. Press the **MEMORY** button [13] on the front panel or **MEMO** button [16] on the remote for more than 3 seconds.
2. The left most column of the station name indicator flashes, indicating the character entry ready status.

**[Operation (Using the SR5300)]**

3. When you press the **TUNING/PRESET** ▲ or ▼ buttons [14] is turned, alphabetic and numeric characters will be displayed in the following order:  
**A → B → C ... Z → 1 → 2 → 3... 0 → - → + → / → (Blank) → A**  
 UP →  
 ← DOWN
4. After selecting the first character to be entered, press the **MEMORY** button [13]. The entry in this column is fixed and the next column starts to flash. Fill the next column and press the **MEMORY** button [13] for more than 1 second to confirm the entry.

**[Operation (Using the remote control unit)]**

First, press the **TUNER** button [3] on the remote control unit. (This operation is not necessary if the remote control unit has already been operated in the TUNER mode.)

3. Enter the character using the ten keypad [9]. For example, to enter "A":  
 1) Press the "1" button. "A" appears on the display column.  
 2) Every time the 1 button is pressed, the displayed character changes in the order: **A → B → C → 1 → A...**  
 Pressing buttons other than the "1" button cause different characters to be displayed in a similar way, so that other alphanumeric characters can be entered. To enter a blank or space, press the "9" button.
4. When the desired character is displayed, press the **MEMO** button [16] to confirm the entry in this column and move to the next column. After having filled all of the 8 columns, press the **MEMO** button [16], for more than 1 second to confirm the entry.

**RDS OPERATION**

Now in use in many countries, RDS (Radio Data System) is a description of the station's programming hidden space in the FM signal. Your new receiver is equipped with RDS to assist in the selection of FM stations using station and network names, rather than broadcast frequencies. Additional RDS functions include the ability to search for programme types.

**RADIO TEXT**

Some RDS stations broadcast RADIO TEXT, which is additional information on the station and programme being broadcast. RADIO TEXT information appears as 'running' text in the display. RADIO TEXT is transmitted character-by-character by the radio station. As a result of that it may take some time until the entire text has been completely received.

**RDS DISPLAY**

When a receiver is tuned to an FM station that is transmitting RDS data, the Front Panel Information Display will automatically show the station name or RDS TEXT in place of the typical display of the station's broadcast frequency. To change the display, press the **RDS** button [12] on the remote controller.

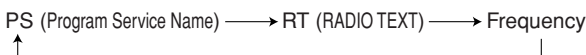

**PROGRAMME TYPE (PTY) DISPLAY**

The RDS system categorizes programmes according to their genre into different programme type (PTY) groups. To display the programme type information of the current station, press the **PTY** button [12] in the TUNER MODE on the remote controller.

**PTY AUTO SEARCH**

Your receiver is equipped to automatically search for stations transmitting any of 29 different programme types. To search for a PTY, follow these procedures:

1. Press the **PTY** button [12] in the TUNER MODE on the remote controller. The current station's PTY will be displayed, or the currently selected PTY group will be displayed in blinking if no station or RDS data is present.
2. To change to a new PTY type, press the **CHANNEL** button [12] until the desired PTY is shown in the display.
3. Once the desired PTY group or type has been selected, press the **PTY** button [12] while the display blink (approx. 5 seconds). The PTY Auto search will start, and the tuner will pause at each station broadcasting RDS PTY information corresponding to the selected choice.
4. To advance to the next RDS station with the desired PTY, press the **PTY** button [12] again within 5 seconds.

NUMBER	DISPLAY	PROGRAMME TYPE
1	POP	Pop Music
2	ROCK	Rock Music
3	MOR	M. O. R. Music
4	LIGHT	Light classical
5	CLASSIC	Serious classical
6	NEWS	News
7	AFFAIR	Current Affairs
8	INFO	Information
9	SPORT	Sport
10	EDUCATE	Education
11	DRAMA	Drama
12	CULTURE	Culture
13	SCIENCE	Science
14	OTHERS	Varied
15	OTHER	Other Music
16	WEATHER	Weather
17	FINANCE	Finance
18	CHILDREN	Children's programmes
19	SOCIAL	Social Affairs
20	RELIGION	Religion
21	PHONE IN	Phone In
22	TRAVEL	Travel
23	HOBBIES	Hobbies
24	JAZZ	Jazz Music
25	COUNTRY	Country Music
26	NATION	National Music
27	OLDIES	Oldies Music
28	FOLK	Folk Music
29	DOCUMENT	Documentary

## PLAYBACK OPERATION

### NORMAL PLAYBACK

1. Press the **POWER** button ① / ②.
2. Press the **FUNCTION SELECTOR** button ⑤ on the front panel or press the **FUNCTION** button ③ on the remote unit to select an input source.
3. Turn the **SURROUND MODE SELECTOR** knob ③ on the front panel or Surround mode buttons ⑨ in the AMP MODE on the remote unit to select the desired surround mode.
4. Adjust the volume level using the **VOLUME** knob ④ on the front panel or press the **MAIN VOL.** button ④ on the remote. If necessary, adjust the tone, press the **TREBLE▲**, **TREBLE▼** ⑭ and **BASS▲**, **BASS▼** ⑮ on the remote unit.

#### Note:

- In case of remote control operation, press one of the function buttons twice within 2 seconds to select the function.

### LISTENING TO A DIFFERENT AUDIO SOURCE WHILE WATCHING A VIDEO SOURCE (Using the remote control unit)

1. Select one of the following video sources  
TV, DVD, VCR1, DSS/VCR2 or AUX.
2. Next, select one of the following audio sources  
FM, AM, CD, TAPE, or CDR/MD.

## TV AUTO ON/OFF FUNCTION

This function allows the component connected to the TV IN jack to control the power (ON/OFF) to the SR5300.

### AUTO POWER ON

1. Be sure TV auto mode is enable. (Refer page 19 : PREFERENCE)
2. Connect your TV TUNER (etc) to the TV IN terminal.  
Be sure to connect the video input.
3. Turn OFF the power to the TV TUNER and the SR5300 will be in standby mode.
4. Turn ON the TV TUNER and tune in a receivable station.
5. When the station is received, the SR5300 turns ON and TV is selected automatically.

### AUTO POWER OFF

1. In the above situation, turn the TV TUNER OFF or select a channel that does not contain any broadcast.
2. The SR5300 switches to STANDBY after approximately 5 minutes.

#### Note:

- AUTO POWER OFF is canceled if the **FUNCTION SELECTOR** button ⑤ is set to a source other than TV. The function reactivates when TV is selected again.

#### Caution:

- Some TV broadcasts may cause the TV AUTO FUNCTION to turn on.
- S-Video terminal does not support "TV AUTO ON/OFF" function.

## SETTING THE SLEEP TIMER

Set the sleep timer while the power is turned on.

1. Turn the power ON and press the **SLEEP** button ⑨ / ⑳.
2. Press the **SLEEP** button ⑨ / ㉓ the number of times to set the desired sleep time in minutes.

Each press of the **SLEEP** button ⑨ / ㉓ or changes the display in the following order:

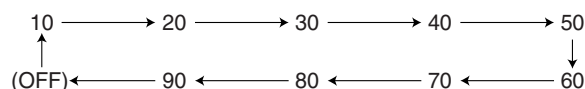

The unit will shut off in the number of minutes indicated.

- \* While the sleep timer is activated, the remaining time can be displayed for approximately 2 seconds by pressing the **SLEEP** button ⑨ / ㉓.
- \* To cancel the Sleep timer, press the **SLEEP** button ⑨ / ㉓ until the display shows to "SLEEP OFF" and the SLEEP indicator disappear.

# ON SCREEN DISPLAY INFORMATION

The on-screen display, which can be activated by the Main unit or remote, appears on the TV screen to show the current setting status of the SR5300.

## Note:

- Each video input function is set PAL or NTSC for TV format of OSD.
  - If this setup does not meet the video input signal, character of OSD can not synchronize.  
So You can select these format function by function.  
Press **OSD** button  $\text{22}$  on the remote controller for 3 seconds or more. "PAL" or "NTSC" will be shown on the display of SR5300, press **OSD** button  $\text{22}$  again to change the TV format. The indication on FL display will change "PAL" → "NTSC" → "PAL"→.
- This setup is memorized with each video input function.

## 1. GENERAL INFORMATION

When the **OSD** button  $\text{22}$  is pressed, the current setting are displayed on the TV monitor.  
This display disappears automatically in about 5 seconds after the button is pressed.

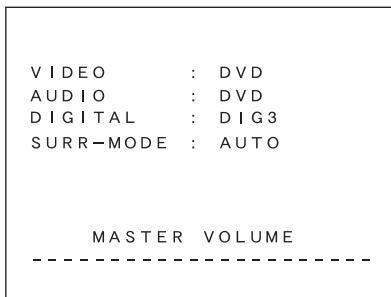

### ① VIDEO SOURCE:

Displays the current video source being selected with the function selector **TV, DVD, VCR1, DSS** or **AUX**.

### ② AUDIO SOURCE:

Displays the current audio source being selected with the function selector **FM, AM, CD, TAPE, CD-R, TV, DVD, VCR1, DSS** or **AUX**.

### ③ DIGITAL INPUT:

Displays the digital input that you are using **DIG-1, DIG-2, DIG-3** or **DIG-4**.

### ④ SURROUND MODE:

Displays the current surround mode  
**AUTO, DOLBY D, DOLBY D EX, PLII MOVIE, PLII MUSIC, PRO LOGIC, DTS, DTS ES, NEO6 CINEMA, NEO6 MUSIC, MULTI CH. ST, CS2 CINEMA, CS2 MUSIC, CS2 MONO, VIRTUAL, MOVIE, HALL, STADIUM, MATRIX, STEREO**

## Note:

- Not all modes will be present depend on selected input.

### ⑤ MASTER VOLUME

Displays the current volume level.  
The volume level is higher at the right of the display.

## Notes:

- The On-Screen Display signals can be output from the TV MONI composite video (RCA) output and the TV MONI S-Video output jacks.
- When you connect both the composite video and S-VIDEO, there will be no signal output from composite video jack.
- With some video equipment or software, the On-Screen Display characters may be distorted due to noise or tracking adjustment error.

## 2. FUNCTION SELECT & SURROUND MODE

When a function selector button or surround mode button is pressed

**VIDEO:** Displays the current video source. When TV,DSS, DVD, VCR1 or AUX is selected with the function selector, both AUDIO and VIDEO shows the same name.

**AUDIO:** Displays the current analog audio input source.

**DIGITAL:** Displays the current digital input source.

**SURR-MODE:** Displays the current Surround mode.

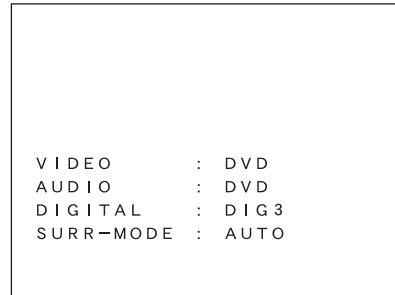

## 3. MASTER VOLUME CONTROL

Displayed when the MASTER volume is varied or a button of the remote control unit is pressed.

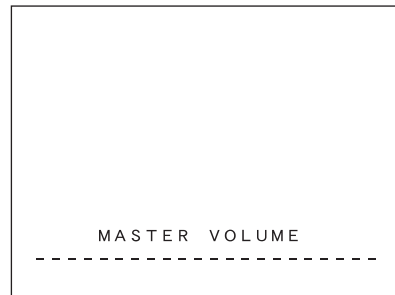

## 4. MUTE

When the **MUTE** button  $\text{11/5}$  is pressed, "MUTE ON" will be shown on screen.

Pressing **MUTE** button  $\text{11/5}$  again will show "MUTE OFF" on screen, and return to the previous volume level.



## 5. SLEEP TIMER

When the **SLEEP** button  $\text{9/23}$  is pressed, the setting on or off and the remaining time of the sleep timer function are displayed.

You can change the mode between on, off and the amount of time to elapse before the unit will shut itself off by cycling the **SLEEP** button  $\text{9/23}$ .





## SURROUND MODE

The SR5300 is equipped with many surround modes. These are provided to reproduce a variety of surround sound effects, according to the content of the source to be played.

The available surround modes may be restricted depending on the input signal and speaker setup.

### AUTO

When this mode is selected, the receiver determines whether the digital input signal is Dolby Digital, Dolby Digital Surround EX, DTS, DTS-ES or PCM-audio.

Surround EX & DTS-ES will operate for multi channel source that has a Dolby Digital Surround EX or DTS-ES auto trigger flag in the digital signal.

When a Dolby Digital or DTS signal is input, the number of channels for which the corresponding signal is encoded will be played.

Inputting a Dolby Digital two channel signal with Dolby surround status automatically subjects that signal to Pro Logic II movie processing before play.

PCM 96 kHz source material can be played in this mode.

#### **Notes:**

- When you use this mode with certain DVD and CD players, performing operations such as "Skip" or "Stop" may momentarily interrupt the output.
- When the signal is not decoded is input for using mode, the mode is changed to AUTO mode automatically. Refer to page 27 to confirm the available decoding mode.

### PRO LOGIC II MOVIE, PRO LOGIC II MUSIC, PRO LOGIC

This mode is used with source materials encoded in Dolby Digital and Dolby Surround.

Dolby Pro Logic II brings the excitement of surround sound to any stereo mix, while making existing Dolby Surround mixes sound more like discrete 5.1 channels Surround sound.

Dolby Pro Logic II has below 3 modes.

#### **Pro Logic II MOVIE**

This mode provides 5.1 channel surround sound from Dolby Surround encoded stereo movie sound tracks.

#### **Pro Logic II MUSIC**

This mode provides 5.1 channel surround sound from conventional stereo sources, analog or digital, such as CD, tape, FM, TV, stereo VCR, etc.

#### **PRO LOGIC**

This mode emulated original Dolby Pro Logic decoding (3/1 surround) suit for Dolby Surround encoded stereo movie soundtracks.

#### **Notes:**

- Pro Logic II mode is available to 2ch input signal which is encoded Dolby Digital or PCM format.
- PCM-audio signals can be subjected to Pro Logic processing when the sampling frequency is 32 kHz, 44.1 kHz or 48 kHz.

### EX/ES

This mode provides 6.1 channel surround for DOLBY DIGITAL EX, DTS-ES encoded source material such as DVD.

This mode cannot be used when an analog input has been selected.

#### **Dolby Digital EX**

In a movie theater, film soundtracks that have been encoded with Dolby Digital surround EX technology are able to reproduce an extra channel which has been added during the mixing of the program.

This channel, called Surround Center, places sounds behind the listener in addition to the currently available front left, front center, front right, surround right, surround left and subwoofer channels.

This additional channel provides the opportunity for more detailed imaging behind the listener and brings more depth, spacious ambience and sound localization than ever before.

Dolby Digital EX is not available in the system without surround center speaker(s).

### **DTS-ES (Discrete 6.1, Matrix 6.1)**

DTS-ES adds the surround center channel audio to the DTS 5.1-channel format to improve the acoustic positioning and makes acoustic image movement more natural with the 6.1-channel reproduction.

This receiver incorporates a DTS-ES decoder, which can handle DTS-ES Discrete-encoded and DTS-ES Matrix-encoded program sources from DVD, etc..

DTS-ES Discrete 6.1 features digital discrete recording of all channels including the surround center channels and higher quality of audio reproduction.

DTS-ES is not available in the system without surround center speaker.

### DTS

This mode is for DTS encoded source materials such as LASER DISC, CD, and DVD.

The DTS mode cannot use when an analog input has been selected.

#### **Note:**

- When use DTS Music source, LFE level is set to - 10 dB by LFE LEVEL of SURROUND in the SETUP MAIN MENU (See page 19) as DTS's recommendation.

### DTS NEO: 6 (NEO:6 CINEMA, NEO6: MUSIC)

This mode decodes 2-channel signals into 6-channel signals using high-accuracy digital matrix technology.

The DTS NEO:6 decoder has near-discrete properties in the frequency characteristics of the channels as well as in channel separation.

According to the signals to be played back, DTS NEO:6 uses either the NEO:6 CINEMA mode optimized for movie playback or the NEO:6 MUSIC mode optimized for music playback.

#### **Note:**

- PCM-audio (32 kHz, 44.1 kHz or 48 kHz) and analog source material can playback in this mode.

### MULTI CH. ST

This mode is used to create a wider, deeper and more natural soundstage from two channel source material.

This is done by feeding the left channel signal to both left front and left surround speaker and the right channel signal to both right front and right surround speaker. Additionally, the center channel reproduces a mix of the right and left channel.

### CIRCLE SURROUND II (CSII-CINEMA, CSII-MUSIC, CSII-MONO)

Circle Surround is designed to enable multi-channel surround sound playback of non-encoded and multi-channel encoded material.

Backward compatibility provides listeners with up to 6.1 channels of surround performance from entire collection of music and film, including broadcast, videotape and stereo recorded music.

Regarding to source material, you can select **CSII-Cinema** mode, **CSII-Music** mode or **CSII-Mono** mode.

#### **Note:**

- PCM-audio (32 kHz, 44.1 kHz or 48 kHz) and analog source material can playback in this mode.

### VIRTUAL

This mode creates a virtualized surround sound experience from a two-speaker (front L and R) playback system playing any multi-channel audio source (such as found on DVDs and digital broadcasts), including Dolby Digital, , Dolby Pro Logic or DTS.

SRS TruSurround, SRS and  symbol are trademarks of SRS Labs, Inc.

SRS TruSurround technology is incorporated under license from SRS Labs, Inc.

### DSP SURROUND (MOVIE, HALL, STADIUM, MATRIX)

These modes provide surround effect processing from each input source material.

They will produce theater, concert hall and stadium like atmospheres. Select as your taste desires.

#### **Note:**

- PCM-audio (32 kHz, 44.1 kHz or 48 kHz) and analog source material can playback in this mode.



**STEREO**

This mode bypasses all surround processing.

Stereo program sources the left and right channels play normally when PCM-audio or analog stereo is input.

With Dolby Digital and DTS sources, the 5.1 multi-channels are converted to two channel stereo. 96 kHz source material can be playback in stereo mode.

**S (SOURCE) - DIRECT**

In the source direct mode, the tone control circuit and bass management configuration are bypassed for full range frequency response and the purist audio reproduction.

96 kHz PCM source material can be play back in this mode.

**Notes:**

- Internal speaker size is setup to front L/R = Large, Center = Large, Surround L/R = Large and Subwoofer = yes automatically. Tone controls and additional processing are also defeated.
- When you use this mode with certain DVD and CD players, performing operations such as "Skip" or "Stop" may momentarily interrupt the output.

**CAUTION****NOTE for DTS signal**

- \* Connected DVD-player, laser-disc player or CD-player needs to support DTS-digital output. You may not be able to play some DTS source signals from certain CD players and LD players even if you connect the player to the SR5300 digitally. This is because the digital signal has been processed (such as the output level, sampling frequency, or frequency response) and the SR5300 cannot recognize the signal as DTS data.
- \* Depending on the player used, DTS play may produce short noise. This is not a malfunction. In such cases, select the surround mode the "DTS" or "DTS-ES".
- \* If DTS cinema, DTS music or DTS-ES mode is selected, digital input cannot be switched to analog input.
- \* When the analog input function has been selected, Surround mode cannot be switched to DTS cinema, DTS music or DTS-ES mode.
- \* While signals from DTS-laser disc or CD are playing in another Surround mode, you cannot switch to digital input or from digital input to analog input by INPUT SETUP in SETUP MAIN MENU or A/D button.
- \* The outputs for the VCR 1 OUT, DSS/VCR 2 OUT, TAPE OUT, and CD-R OUT output analog audio signals. Do not record from CDs or LDs that support DTS using these outputs. If you do, the DTS-encoded signal will be recorded as noise.

**NOTE for Dolby Digital Surround EX signal**

- \* When playing Dolby Digital Surround EX-encoded software in 6.1 channels, it is required to set the EX/ES mode.
- \* Note that some of Dolby Digital Surround EX-encoded software does not contain the identification signal. In this case, set the EX/ES mode manually.

**NOTE for 96kHz PCM audio**

- \* AUTO, Source- DIRECT, and STEREO modes can be used when playing PCM signals with a sampling frequency of 96 kHz (such as from DVD-Video discs that contain 24 bit, 96 kHz audio). If such signals are input during playback in one of the other surround modes, output from SR5300 will be muted.
- \* Certain DVD player models inhibit digital output. For details, refer to the player's operation manual.
- \* Some DVD formatted discs featured copy protection. When using such disc, 96 kHz PCM signal is not output from the DVD player. For details, refer to the player's operation manual.

### The relation between the selected surround mode and the input signal

The surround mode is selected with the surround mode selector knob of the SR5300 or the remote control unit. However, the sound from the speakers depend upon the relationship between the selected surround mode and the input signal. They are as follows;

SURROUND MODE	INPUT SIGNAL	OUTPUT CHANNELS					FLUORESCENT INDICATOR	
		L/R	C	SLSR	SC	SW	FORMAT STATUS & SURROUND MODE	TEMPORARY DISPLAY STATUS
AUTO	DOLBY DIGITAL(5.1CH)	○	○	○	-	○	AUTO, DOLBY, DIGITAL	AUTO
	DOLBY DIGITAL(2CH)	○	-	-	-	○	AUTO, DOLBY, DIGITAL	AUTO
	DOLBY DIGITAL (2CH:Lt/Rt)	○	○	○	-	○	AUTO, DOLBY, DIGITAL, PRO LOGIC II	AUTO
	DOLBY DIGITAL EX(6.1CH)	○	○	○	○	○	AUTO, DOLBY, DIGITAL, SURROUND EX	AUTO
	96KHZ PCM	○	-	-	-	-	AUTO, STEREO, PCM	AUTO -> 96KHz
	PCM(AUDIO)	○	-	-	-	○	AUTO, STEREO	AUTO
	ANALOG	○	-	-	-	○	AUTO, STEREO	AUTO
	DTS(5.1CH)	○	○	○	-	○	AUTO, DTS	AUTO
	DTS-ES(6.1CH)	○	○	○	○	○	AUTO, DTS, ES	AUTO
	PL2 MOVIE	DOLBY DIGITAL(5.1CH)	○	○	○	-	○	DOLBY, DIGITAL
DOLBY DIGITAL(2CH)		○	○	○	-	○	DOLBY, DIGITAL, PRO LOGIC II	DOLBY PL2 MV
DOLBY DIGITAL (2CH:Lt/Rt)		○	○	○	-	○	DOLBY, DIGITAL, PRO LOGIC II	DOLBY PL2 MV
DOLBY DIGITAL EX(6.1CH)		○	○	○	-	○	DOLBY, DIGITAL	DOLBY D
96KHZ PCM		-	-	-	-	-		
PCM(AUDIO)		○	○	○	-	○	DOLBY, PRO LOGIC II, PCM	DOLBY PL2 MV
ANALOG		○	○	○	-	○	DOLBY, PRO LOGIC II	DOLBY PL2 MV
DTS(5.1CH)		-	-	-	-	-		
DTS-ES(6.1CH)		-	-	-	-	-		
PL2 MUSIC		DOLBY DIGITAL(5.1CH)	○	○	○	-	○	DOLBY, DIGITAL
	DOLBY DIGITAL(2CH)	○	○	○	-	○	DOLBY, DIGITAL, PRO LOGIC II	DOLBY PL2 MS
	DOLBY DIGITAL (2CH:Lt/Rt)	○	○	○	-	○	DOLBY, DIGITAL, PRO LOGIC II	DOLBY PL2 MS
	DOLBY DIGITAL EX(6.1CH)	○	○	○	-	○	DOLBY, DIGITAL	DOLBY D
	96KHZ PCM	-	-	-	-	-		
	PCM(AUDIO)	○	○	○	-	○	DOLBY, PRO LOGIC II, PCM	DOLBY PL2 MS
	ANALOG	○	○	○	-	○	DOLBY, PRO LOGIC II	DOLBY PL2 MS
	DTS(5.1CH)	-	-	-	-	-		
	DTS-ES(6.1CH)	-	-	-	-	-		
	PRO LOGIC	DOLBY DIGITAL(5.1CH)	○	○	○	-	○	DOLBY, DIGITAL
DOLBY DIGITAL(2CH)		○	○	○	-	○	DOLBY, DIGITAL, PRO LOGIC	DOLBY PL
DOLBY DIGITAL (2CH:Lt/Rt)		○	○	○	-	○	DOLBY, DIGITAL, PRO LOGIC	DOLBY PL
DOLBY DIGITAL EX(6.1CH)		○	○	○	-	○	DOLBY, DIGITAL	DOLBY D
96KHZ PCM		-	-	-	-	-		
PCM(AUDIO)		○	○	○	-	○	DOLBY, PRO LOGIC, PCM	DOLBY PL
ANALOG		○	○	○	-	○	DOLBY, PRO LOGIC	DOLBY PL
DTS(5.1CH)		-	-	-	-	-		
DTS-ES(6.1CH)		-	-	-	-	-		
EX/ES		DOLBY DIGITAL(5.1CH)	○	○	○	○	○	DOLBY, DIGITAL, SURROUND EX
	DOLBY DIGITAL(2CH)	-	-	-	-	-		
	DOLBY DIGITAL (2CH:Lt/Rt)	-	-	-	-	-		
	DOLBY DIGITAL EX(6.1CH)	○	○	○	○	○	DOLBY, DIGITAL, SURROUND EX	DOLBY D EX
	96KHZ PCM	-	-	-	-	-		
	PCM(AUDIO)	-	-	-	-	-		
	ANALOG	-	-	-	-	-		
	DTS(5.1CH)	○	○	○	○	○	DTS, ES	DTS ES
	DTS-ES(6.1CH)	○	○	○	○	○	DTS, ES	DTS ES
	DTS	DOLBY DIGITAL(5.1CH)	-	-	-	-	-	
DOLBY DIGITAL(2CH)		-	-	-	-	-		
DOLBY DIGITAL (2CH:Lt/Rt)		-	-	-	-	-		
DOLBY DIGITAL EX(6.1CH)		-	-	-	-	-		
96KHZ PCM		-	-	-	-	-		
PCM(AUDIO)		-	-	-	-	-		
ANALOG		-	-	-	-	-		
DTS(5.1CH)		○	○	○	-	○	DTS	DTS
DTS-ES(6.1CH)		○	○	○	-	○	DTS	DTS
Neo:6 CINEMA Neo:6 MUSIC		DOLBY DIGITAL(5.1CH)	-	-	-	-	-	
	DOLBY DIGITAL(2CH)	-	-	-	-	-		
	DOLBY DIGITAL (2CH:Lt/Rt)	-	-	-	-	-		
	DOLBY DIGITAL EX(6.1CH)	-	-	-	-	-		
	96KHZ PCM	-	-	-	-	-		
	PCM(AUDIO)	○	○	○	○	○	PCM	NEO6 CINEMA or MUSIC
	ANALOG	○	○	○	○	○		NEO6 CINEMA or MUSIC
MULTI CH. ST	DOLBY DIGITAL(5.1CH)	○	○	○	○	○	DOLBY, DIGITAL, SURROUND EX	M-CH STEREO
	DOLBY DIGITAL(2CH)	○	○	○	○	○	DOLBY, DIGITAL	M-CH STEREO
	DOLBY DIGITAL (2CH:Lt/Rt)	○	○	○	○	○	DOLBY, DIGITAL	M-CH STEREO
	DOLBY DIGITAL EX(6.1CH)	○	○	○	○	○	DOLBY, DIGITAL, SURROUND EX	M-CH STEREO
	96KHZ PCM	-	-	-	-	-		
	PCM(AUDIO)	○	○	○	○	○	PCM	M-CH STEREO
	ANALOG	○	○	○	○	○		M-CH STEREO
	DTS(5.1CH)	○	○	○	○	○	DTS, ES	M-CH STEREO
	DTS-ES(6.1CH)	○	○	○	○	○	DTS, ES	M-CH STEREO

SURROUND MODE	INPUT SIGNAL	OUTPUT CHANNELS					FLUORESCENT INDICATOR	
		L/R	C	SL/SR	SC	SW	FORMAT STATUS & SURROUND MODE	TEMPORARY DISPLAY STATUS
CS2 CINEMA CS2 MUSIC CS2 MONO	DOLBY DIGITAL(5.1CH)	-	-	-	-	-		
	DOLBY DIGITAL(2CH)	-	-	-	-	-		
	DOLBY DIGITAL(2CH:Lt/Rt)	-	-	-	-	-		
	DOLBY DIGITAL EX(6.1CH)	-	-	-	-	-		
	96KHZ PCM	-	-	-	-	-		
	PCM(AUDIO)	○	○	○	○	○	PCM	CS-2 CINEMA or MUSIC or MONO
	ANALOG	○	○	○	○	○		CS-2 CINEMA or MUSIC or MONO
	DTS(5.1CH)	-	-	-	-	-		
VIRTUAL	DOLBY DIGITAL(5.1CH)	○	-	-	-	○	VIRTUAL, DOLBY, DIGITAL	VIRTUAL
	DOLBY DIGITAL(2CH)	○	-	-	-	○	VIRTUAL, DOLBY, DIGITAL, PRO LOGIC	VIRTUAL
	DOLBY DIGITAL(2CH:Lt/Rt)	○	-	-	-	○	VIRTUAL, DOLBY, DIGITAL, PRO LOGIC	VIRTUAL
	DOLBY DIGITAL EX(6.1CH)	○	-	-	-	○	VIRTUAL, DOLBY, DIGITAL	VIRTUAL
	96KHZ PCM	-	-	-	-	-		
	PCM(AUDIO)	○	-	-	-	○	VIRTUAL, PRO LOGIC, PCM	VIRTUAL
	ANALOG	○	-	-	-	○	VIRTUAL, PRO LOGIC	VIRTUAL
	DTS(5.1CH)	○	-	-	-	○	VIRTUAL, DTS	VIRTUAL
(DSP SURROUND) MOVIE HALL STADIUM MATRIX	DTS-ES(6.1CH)	○	-	-	-	○	VIRTUAL, DTS	VIRTUAL
	DOLBY DIGITAL(5.1CH)	-	-	-	-	-		
	DOLBY DIGITAL(2CH)	-	-	-	-	-		
	DOLBY DIGITAL(2CH:Lt/Rt)	-	-	-	-	-		
	DOLBY DIGITAL EX(6.1CH)	-	-	-	-	-		
	96KHZ PCM	-	-	-	-	-		
	PCM(AUDIO)	○	○	○	○	○	DSP SOUND, PCM	MOVIE or HALL or STADIUM or MATRIX
	ANALOG	○	○	○	○	○	DSP SOUND	MOVIE or HALL or STADIUM or MATRIX
STEREO	DTS(5.1CH)	-	-	-	-	-		
	DTS-ES(6.1CH)	-	-	-	-	-		
	DOLBY DIGITAL(5.1CH)	○	-	-	-	○	STEREO, DOLBY, DIGITAL	STEREO
	DOLBY DIGITAL(2CH)	○	-	-	-	○	STEREO, DOLBY, DIGITAL	STEREO
	DOLBY DIGITAL(2CH:Lt/Rt)	○	-	-	-	○	STEREO, DOLBY, DIGITAL	STEREO
	DOLBY DIGITAL EX(6.1CH)	○	-	-	-	○	STEREO, DOLBY, DIGITAL	STEREO
	96KHZ PCM	○	-	-	-	-	STEREO, PCM	STEREO -> 96KHz
	PCM(AUDIO)	○	-	-	-	○	STEREO, PCM	STEREO
S-DIRECT	ANALOG	○	-	-	-	○	STEREO	STEREO
	DTS(5.1CH)	○	-	-	-	○	STEREO, DTS	STEREO
	DTS-ES(6.1CH)	○	-	-	-	○	STEREO, DTS	STEREO
	DOLBY DIGITAL(5.1CH)	○	○	○	-	○	DIRECT, DOLBY, DIGITAL	S-DIRECT
	DOLBY DIGITAL(2CH)	○	-	-	-	○	DIRECT, DOLBY, DIGITAL	S-DIRECT
	DOLBY DIGITAL(2CH:Lt/Rt)	○	○	○	-	○	DIRECT, DOLBY, DIGITAL	S-DIRECT
	DOLBY DIGITAL EX(6.1CH)	○	○	○	○	○	DIRECT, DOLBY, DIGITAL, SURROUND EX	S-DIRECT
	96KHZ PCM	○	-	-	-	-	DIRECT, STEREO, PCM	S-DIRECT -> 96KHz
PCM(AUDIO)	○	-	-	-	○	DIRECT, STEREO, PCM	S-DIRECT	
	ANALOG	○	-	-	-	○	DIRECT, STEREO	S-DIRECT
	DTS(5.1CH)	○	○	○	-	○	DIRECT, DTS	S-DIRECT
	DTS-ES(6.1CH)	○	○	○	○	○	DIRECT, DTS, ES	S-DIRECT

**Note:**

- Dolby Digital (2 ch: Lt/Rt): signal with Dolby Surround flag Speakers are full set.
- No sound outputs from the surround speaker, center speaker and subwoofer if the DVD disc has no surround data.

L/R : Front speakers  
 C : Center speaker  
 SL/SR : Surround speakers  
 SC : Surround Center speaker  
 SW : Sub woofer speaker

# TROUBLE SHOOTING

## In case of trouble, check the following before calling for service:

1. Are the connections made properly ?
2. Are you operating the unit properly following user's guide ?
3. Are the power amplifiers and speaker working properly ?

If the unit does not operate properly, check items shown in the following table.

If your trouble cannot be recovered with the remedy actions listed in the following table, malfunction of the internal circuitry is suspected; immediately unplug the power cable and contact your dealer, nearest Marantz distributor or the Marantz Service Center in your country.

SYMPTOM	CAUSE	REMEDY
SR5300 cannot be turned up.	The power plug is not connected.	Connect the power plug to the outlet.
No sound and picture are output even when power is on.	Mute is on. The input cable is not connected correctly. The master volume control is turned all the way down. The function selector position is wrong.	Cancel mute using the remote control unit. See the connection diagram and connect the cables correctly. Adjust the master volume. Select correct position.
Speaker does not outputting any sound.	The headphones are connected to the headphone jack.	Disconnect the headphones. (Speakers will not output sound when headphones are connected.)
Sound and pictures from other than equipment selected with the function selector.	Input cable connected incorrectly.	Connect the cable correctly by referring to the connection diagram.
Sound from the wrong channel is output from the speaker.	Speaker cable connected incorrectly.	Connect the cable correctly by referring to the connection diagram.
No sound is output from the center speaker.	The center speaker cable connection is incomplete. STEREO has been selected for Surround mode.  Center = NONE has been selected in SETUP mode.	Connect the cable correctly. When STEREO is selected for Surround mode, no sound will be output from the center speaker. Set another Surround mode. Make the correct setting.
No sound is output from the surround speakers.	The surround speaker cable connection is incomplete. STEREO has been selected for Surround mode.  Surround = NONE has been selected in SETUP mode.	Connect the cable correctly. When STEREO has been selected for Surround mode, no sound will be output from the surround speaker. Set another Surround mode. Make the correct setting.
No output to Sub Woofer Out.	Sub-woofer = NONE has been selected in SETUP mode.	Select Sub-woofer = YES.
Surround mode cannot be changed.	The headphones are connected to the jack.	Disconnect the headphones. (When headphones are connected, Surround mode will be fixed to STEREO.)
Noise is produced during DTS-encoded CD or laser disc play.	Analog has been selected for input.	Be sure to perform digital connection, select digital input, then play.
DTS sources cannot be played.	Surround mode is set to DOLBY. The DVD or LD player is not DTS digital out capable.	Select other mode. Use a player which responds to DTS-digital out.
Player skips during play of a DTS source and produces noise.	Data error occurred during player skip.	Set Surround mode to DTS.
A 96kHz PCM signal cannot be played.	The disc player is not 96kHz PCM digital out capable. Surround mode is set to other than STEREO and AUTO.	Use a player that responds to 96kHz PCM digital out. Set Surround mode to STEREO or AUTO.
A specific channel does not produce output.	Nothing recorded on source.	Check the encoded channel on the source side.
FM or AM reception fails.	Antenna connection is incomplete.	Correctly connect the indoor FM and AM antennas to FM and AM antenna outlets.
Noise is heard during AM reception.	Reception is affected by other electrical fields.	Try changing location where the AM indoor antenna is set up.
Noise is heard during FM reception.	The radio waves from the broadcasting station are weak.	Install an FM outdoor antenna.
Cannot get programmed station when the PRESET button is pressed.	Preset data has been erased.	Disconnecting power plug for long periods of time will erase preset data. If that happens, input the preset data again.
Control with the remote control unit fails.	Batteries are consumed. Remote controller's function-key setting is wrong. The distance between this SR5300 and the remote commander is too far. Something is blocking SR5300 and the remote commander.	Replace all the batteries with new ones. Select different position from which equipment will be controlled. Move closer to this SR5300.  Remove offending object.

## GENERAL MALFUNCTION

If the equipment malfunctions, this may be because an electrostatic discharge or AC line interference has corrupted the information in the equipment memory circuits. Therefore:

- disconnect the plug from the AC line supply
- after waiting at least three minutes, reconnect the plug to the AC line supply
- re-attempt to operate the equipment

### **Memory backup**

- In case a power outage occurs or the power cord is accidentally unplugged, the SR5300 is equipped with a backup function to prevent memory data such as the preset memory from being erased.

The memory functions are backed up for up to about one week.

### **Note:**

- First of all keep SR5300 Standby or Powered-on more than 6 hours, to sufficient time for memory back up.

## HOW TO RESET THE UNIT

Should the operation or display seem to be abnormal, reset the unit with the following procedure.

- 1.** The SR5300 is turned on, press and hold the **A/D** ⑦ and **DIMMER** ⑩ buttons simultaneously for 3 seconds or more.

### **Note:**

- Remember that the procedure will reset the settings of the function selector, Surround mode, delay time, TUNER PRESET etc., to their initial settings.

# TECHNICAL SPECIFICATIONS

## FM TUNER SECTION

Frequency Range ..... 87.5 - 108.0 MHz  
 Usable Sensitivity ..... IHF 1.8  $\mu$ V/16.4 dBf  
 Signal to Noise Ratio ..... Mono/Stereo 75/70 dB  
 Distortion ..... Mono/Stereo 0.2/0.3 %  
 Stereo Separation ..... 1 kHz 45 dB  
 Alternate Channel Selectivity .....  $\pm$  300 kHz 60 dB  
 Image Rejection ..... 98 MHz 70 dB  
 Tuner Output Level ..... 1 kHz,  $\pm$  40 kHz Dev 500 mV

## AM TUNER SECTION

Frequency Range ..... AM: 522 - 1611 kHz  
 Signal to Noise Ratio ..... 50 dB  
 Usable Sensitivity ..... Loop 400  $\mu$ V/m  
 Distortion ..... 400 Hz, 30 % Mod. 0.5 %  
 Selectivity .....  $\pm$  18 kHz 60 dB

## AUDIO SECTION

Continuous Power Output (8 ohms / 20 Hz - 20 kHz)  
 Front ..... 90 W  
 Center ..... 90 W  
 Surround ..... 90 W  
 THD Front (20 Hz - 20 kHz) ..... 8 ohms 0.05 %  
 Input Sensitivity/Impedance  
 Linear ..... 340 mV/ 47 Kohms  
 Signal to Noise Ratio  
 Linear ..... 105 dB

## VIDEO SECTION

Television Format ..... NTSC/PAL  
 Input Level/Impedance ..... 1 Vp-p/ 75 ohms  
 Output Level/Impedance ..... 1 Vp-p/ 75 ohms  
 Video Frequency Response ..... 5 Hz to 8 MHz (-1 dB)  
 S/N ..... 60 dB

## GENERAL

Power Requirement ..... AC 230 V 50 Hz  
 Power Consumption ..... 310 W  
 Dimension (MAX)  
 Width ..... 440 mm  
 Height ..... 164 mm  
 Depth ..... 425 mm  
 Weight ..... 12.9 Kg

## ACCESSORIES

Remote Control Unit RC5300SR ..... 1  
 AAA-size batteries ..... 2  
 FM Feeder Antenna ..... 1  
 FM Antenna Converter ..... 1  
 AM Loop Antenna ..... 1  
 AC Power Cord ..... 1  
 Registration Card ..... 1  
 User Guide ..... 1

Specifications subject to change without prior notice.

# DIMENSION

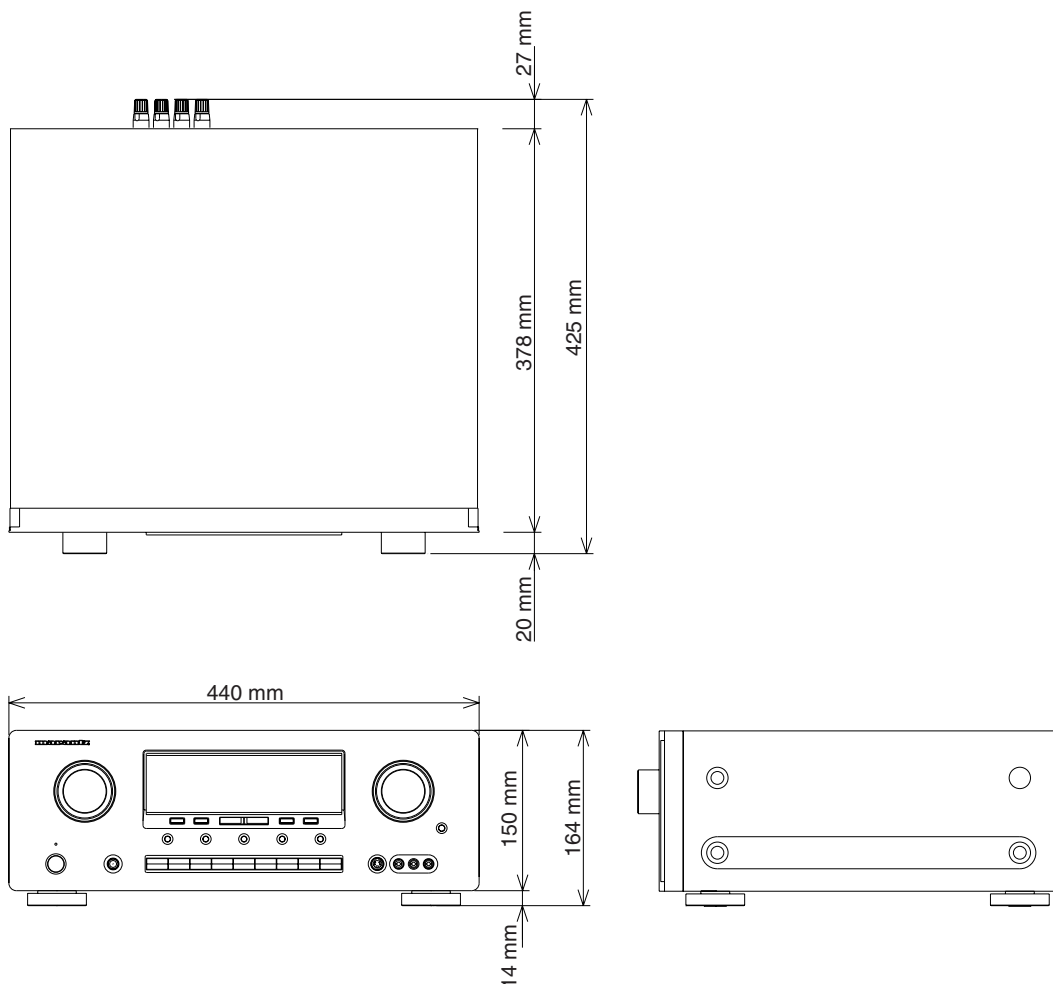



# SETUP CODES

## CD

Aiwa	0151, 0184
Burmester	0447
California Audio Labs	0056, 0330
Carver	0184, 0206, 0326, 0464
DKK	0027
Denon	0030
Emerson	0332
Fisher	0201, 0206
Garrard	0420, 0447
Genexxa	0059, 0332
Harman/Kardon	0184, 0200
Hitachi	0059
JVC	0099
Kenwood	0055, 0064, 0217
Krell	0184
LXI	0332
Linn	0184
Luxman	0062, 0120, 0293, 0354, 0355, 0457, 0459, 0510, 0516
MCS	0056
MTC	0447
Magnavox	0184, 0332
Marantz	0056, 0184, 0207, 1207, 0999,
Mission	0184
NAD	0046, 0326, 0343, 0747, 0748
NSM	0184
Nakamichi	0106, 0174, 0466, 0471, 0691
Nikko	0201
Onkyo	0128
Optimus	0027, 0059, 0064, 0172, 0206, 0332, 0447, 0464, 0495
Panasonic	0056, 0330
Parasound	0447
Philips	0184
Pioneer	0059, 0271, 0332, 0495
Polk Audio	0184
Proton	0184
QED	0184
Quasar	0056
RCA	0059, 0080, 0206, 0332, 0495, 0791
Realistic	0206, 0207, 0447
Rotel	0184, 0447
SAE	0184
Sansui	0184, 0332
Sanyo	0206
Scott	0332
Sears	0332
Sharp	0064, 0207
Sherwood	0207
Sonic Frontiers	0184
Sony	0027, 0212
Soundesign	0172
Tascam	0447
Teac	0201, 0207, 0420, 0447
Technics	0056, 0330
Toshiba	0046, 0326
Victor	0099
Wards	0080, 0184
Yamaha	0063, 0214
Yorx	0488

## MD PLAYERS

Denon	1900
Kenwood	1708, 1853
Marantz	1207
Onkyo	1895
Optimus	1090
Pioneer	1090
Sharp	1888
Sherwood	1094
Sony	1517
Yamaha	1915

## CDR

Marantz	0999
---------	------

## TAPE

Aiwa	0056, 0224
Carver	0056
Denon	0103
Garrard	0335, 0336
Harman/Kardon	0056, 0209
JVC	0271, 0300
Kenwood	0097
Magnavox	0056
Marantz	0056
NAD	0171
Onkyo	0162, 0309
Optimus	0054, 0247
Panasonic	0256
Philips	0056
Pioneer	0054, 0126, 0247
Polk Audio	0056
RCA	0054, 0247
Samsung	0418, 0419
Sansui	0056
Sony	0197, 0270, 0318
Teac	0307, 0335, 0336, 0418, 0419
Technics	0256
Victor	0300
Wards	0054
Yamaha	0121, 0124

## SAT (DSS)

AlphaStar	0799
Echostar	0802, 1032
Expressvu	0802
General Instrument	0388, 0654, 0896
HTS	0802
Hitachi	0846
Hughes Network Systems	0776
JVC	0802
Jerrold	0388, 0654
Magnavox	0749, 0751
Memorex	0751
Next Level	0896
Panasonic	0728
Philips	0749, 0751, 1103
Primestar	0388, 0654
RCA	0170, 0419, 0593, 0882
Radio Shack	0896
Sony	0666
Star Choice	0896
Toshiba	0776, 0817
Uniden	0749, 0751
Zenith	0883

**TV**

AOC .....	0046, 0057
Admiral .....	0120, 0490
Aiko .....	0119
Akai .....	0057
Alaron .....	0206
Ambassador .....	0204
America Action .....	0207
Anam .....	0207
Audiovox .....	0119, 0207, 0478, 0650
Baysonic .....	0207
Belcor .....	0046
Bell & Howell .....	0043, 0181
Bradford .....	0207
Brockwood .....	0046
Broksonic .....	0263, 0490
CXC .....	0207
Candle .....	0057, 0083
Carnivale .....	0057
Carver .....	0081
Celebrity .....	0027
Cineral .....	0119, 0478
Citizen .....	0057, 0083, 0087, 0119
Concerto .....	0083
Contec .....	0207
Craig .....	0207
Crosley .....	0081
Crown .....	0207
Curtis Mathes .....	0043, 0057, 0074, 0078, 0081, 0083, 0087, 0120, 0172, 0181, 0193, 0478, 1174, 1374
Daewoo .....	0046, 0119, 0478, 0650, 0651
Daytron .....	0046
Denon .....	0172
Dumont .....	0044, 0046
Dwin .....	0747, 0801
Electroband .....	0027
Emerson .....	0046, 0181, 0204, 0205, 0206, 0207, 0263, 0490, 0650, 0651
Envision .....	0057
Fisher .....	0181
Fujitsu .....	0206, 0710
Funai .....	0206, 0207
Futuretech .....	0207
GE .....	0074, 0078, 0120, 0205, 0478, 1174, 1374
Gibraltar .....	0044, 0046, 0057
GoldStar .....	0046, 0057, 0083, 0205
Gradiente .....	0080, 0083
Grunpy .....	0206, 0207
Hallmark .....	0205
Harley Davidson .....	0206
Harman/Kardon .....	0081
Harvard .....	0207
Hitachi .....	0043, 0083, 0172
Infinity .....	0081
Inteq .....	0044
JBL .....	0081
JCB .....	0027
JVC .....	0080
KEC .....	0207
KTV .....	0057, 0207
Kenwood .....	0046, 0057
LG .....	0083
LXI .....	0074, 0081, 0181, 0183, 0205
Logik .....	0043
Luxman .....	0083
MGA .....	0046, 0057, 0177, 0205
MTC .....	0046, 0057, 0083, 0087
Magnavox .....	0057, 0081, 0206, 1281
Majestic .....	0043
Marantz .....	0057, 0081, 1581
Matsushita .....	0277
Megatron .....	0172, 0205
Memorex .....	0043, 0083, 0177, 0181, 0205, 0206, 0277, 0490
Midland .....	0044, 0074, 0078
Mitsubishi .....	0046, 0120, 0177, 0205
Motorola .....	0120
Multitech .....	0207
NAD .....	0183, 0193, 0205
NEC .....	0046, 0057, 0083
NTC .....	0119
Nikko .....	0057, 0119, 0205
Onwa .....	0207
Optimus .....	0181, 0193, 0277
Optonica .....	0120, 0192
Orion .....	0206, 0263, 0490
Panasonic .....	0078, 0277
Penney .....	0046, 0057, 0074, 0078, 0083, 0087, 0183, 0205, 1374
Philco .....	0046, 0057, 0081, 0172, 0490
Philips .....	0081
Pilot .....	0046, 0057
Pioneer .....	0193, 0706
Portland .....	0046, 0119
Prism .....	0078
Proscan .....	0074
Proton .....	0205
Pulsar .....	0044, 0046
Quasar .....	0078, 0192, 0277
RCA .....	0046, 0074, 0078, 0117, 0120, 0706, 1074, 1174, 1274, 1374, 1474
Radio Shack .....	0046, 0057, 0074, 0083, 0181, 0192, 0205, 0207
Realistic .....	0046, 0057, 0083, 0181, 0192, 0205, 0207
Runco .....	0044, 0057, 0630
SSS .....	0046, 0207
Sampo .....	0057
Samsung .....	0046, 0057, 0083, 0087, 0205
Sansei .....	0478
Sansui .....	0490
Sanyo .....	0181
Scimitsu .....	0046
Scotch .....	0205
Scott .....	0046, 0205, 0206, 0207, 0263
Sears .....	0074, 0081, 0083, 0181, 0183, 0205, 0206
Semivox .....	0207
Semp .....	0183
Sharp .....	0120, 0192, 0715
Shogun .....	0046
Signature .....	0043
Sony .....	0027
Soundesign .....	0205, 0206, 0207
Starlite .....	0207
Supreme .....	0027
Sylvania .....	0057, 0081
TMK .....	0083, 0204, 0205
TNCi .....	0044
Tandy .....	0120
Technics .....	0078, 0277
Technol Ace .....	0206
Techwood .....	0078, 0083
Teknika .....	0043, 0046, 0081, 0083, 0087, 0119, 0177, 0206, 0207
Telefunken .....	0083
Toshiba .....	0087, 0181, 0183, 1283
Vector Research .....	0057
Victor .....	0080
Vidikron .....	0081
Vidtech .....	0046, 0205
Wards .....	0043, 0046, 0057, 0081, 0083, 0192, 0205, 0206
White Westinghouse .....	0490, 0650, 0651
Yamaha .....	0046, 0057
Zenith .....	0043, 0044, 0119, 0490, 0651

**VCR**

Admiral ..... 0075, 0236  
Adventura ..... 0027  
Aiko ..... 0305  
Aiwa ..... 0027, 0064  
America Action ..... 0305  
American High ..... 0062  
Asha ..... 0267  
Audiovox ..... 0064  
Beaumarck ..... 0267  
Bell & Howell ..... 0131  
Broksonic ..... 0148, 0211, 0236, 0506  
CCE ..... 0099, 0305  
Calix ..... 0064  
Canon ..... 0062  
Carver ..... 0108  
Cineral ..... 0305  
Citizen ..... 0064, 0305  
Colt ..... 0099  
Craig ..... 0064, 0074, 0099, 0267  
Curtis Mathes ..... 0062, 0087, 0189  
Cybernex ..... 0267  
Daewoo ..... 0072, 0305  
Denon ..... 0069  
Dynatech ..... 0027  
Electrohome ..... 0064  
Electroponic ..... 0064  
Emerex ..... 0059  
Emerson ..... 0027, 0064, 0070, 0148, 0211, 0236, 0305, 0506  
Fisher ..... 0074, 0131  
Fuji ..... 0062  
Funai ..... 0027  
GE ..... 0062, 0075, 0087, 0267  
Garrard ..... 0027  
Go Video ..... 0459  
GoldStar ..... 0064  
Gradiente ..... 0027  
HI-Q ..... 0074  
Harley Davidson ..... 0027  
Harman/Kardon ..... 0108  
Harwood ..... 0099  
Hitachi ..... 0027, 0069  
Hughes Network Systems ..... 0069  
JVC ..... 0094  
KEC ..... 0064, 0305  
KLH ..... 0099  
Kenwood ..... 0094  
Kodak ..... 0062, 0064  
LXI ..... 0064  
Lloyd's ..... 0027  
Logik ..... 0099  
MEI ..... 0062  
MGA ..... 0070, 0267  
MGN Technology ..... 0267  
MTC ..... 0027, 0267  
Magnasonic ..... 0305  
Magnavox ..... 0027, 0062, 0066, 0108  
Magnin ..... 0267  
Marantz ..... 0062, 0108, 1408  
Marta ..... 0064  
Matsushita ..... 0062, 0189  
Memorex ..... 0027, 0062, 0064, 0066, 0074, 0075, 0131, 0189,  
0236, 0267, 0506, 1064, 1189, 1289  
Minolta ..... 0069  
Mitsubishi ..... 0070, 0075, 0094  
Motorola ..... 0062, 0075  
Multitech ..... 0027, 0099

NAD ..... 0085  
NEC ..... 0094, 0131  
Nikko ..... 0064  
Noblex ..... 0267  
Olympus ..... 0062  
Optimus ..... 0064, 0075, 0085, 0131, 0189, 0459, 1075, 1089,  
1189, 1289  
Orion ..... 0211, 0236, 0506  
Panasonic ..... 0062, 0189, 0252, 0643, 1089, 1189, 1289  
Penney ..... 0062, 0064, 0069, 0267  
Pentax ..... 0069  
Philco ..... 0062, 0236, 0506  
Philips ..... 0062, 0108, 0645, 1108, 1208  
Pilot ..... 0064  
Pioneer ..... 0085, 0094  
Polk Audio ..... 0108  
Profitronic ..... 0267  
Proscan ..... 0087  
Protec ..... 0099  
Pulsar ..... 0066  
Quasar ..... 0062, 0189, 1189  
RCA ..... 0062, 0069, 0075, 0085, 0087, 0267  
Radio Shack ..... 0027, 1064  
Radix ..... 0064  
Randex ..... 0064  
Realistic ..... 0027, 0062, 0064, 0074, 0075, 0131  
ReplayTV ..... 0641, 0643  
Runco ..... 0066  
STS ..... 0069  
Samsung ..... 0072, 0267  
Sanky ..... 0066, 0075  
Sansui ..... 0027, 0094, 0236, 0506  
Sanyo ..... 0074, 0131, 0267  
Scott ..... 0070, 0072, 0148, 0211  
Sears ..... 0027, 0062, 0064, 0069, 0074, 0131  
Semp ..... 0072  
Sharp ..... 0075  
Shintom ..... 0099  
Shogun ..... 0267  
Singer ..... 0099  
Sony ..... 0027, 0059, 0062, 1059  
Sylvania ..... 0027, 0062, 0070, 0108  
Symphonic ..... 0027  
TMK ..... 0267  
Teac ..... 0027  
Technics ..... 0062, 0189  
Teknika ..... 0027, 0062, 0064  
Thomas ..... 0027  
Tivo ..... 0645  
Toshiba ..... 0070, 0072  
Totevision ..... 0064, 0267  
Unitech ..... 0267  
Vector ..... 0072  
Video Concepts ..... 0072  
Videosonic ..... 0267  
Wards ..... 0027, 0062, 0069, 0074, 0075, 0087, 0099, 0108, 0267  
White Westinghouse ..... 0099, 0236, 0305  
XR-1000 ..... 0027, 0062, 0099  
Zenith ..... 0027, 0066, 0236, 0506

## DVD

Aiwa .....	0668
Apex .....	0699
Denon .....	0517, 0661
Fisher .....	0697
GE .....	0549
Harman/Kardon .....	0609
Hitachi .....	0691
Hiteker .....	0699
JVC .....	0585, 0650
Kenwood .....	0561, 0709
Magnavox .....	0530, 0702
Marantz .....	0566
Mitsubishi .....	0548
Onkyo .....	0530, 0654
Optimus .....	0598
Oritron .....	0678
Panasonic .....	0517, 0659
Philips .....	0530, 0566
Pioneer .....	0552, 0598, 0659
Proscan .....	0549
RCA .....	0549, 0598
Samsung .....	0600
Sharp .....	0657
Sony .....	0560
Technics .....	0517
Theta Digital .....	0598
Toshiba .....	0530
Yamaha .....	0517, 0572
Zenith .....	0530, 0618

COUNTRY	COMPANY	ADDRESS
ALGERIE	Azur 2000	8, Lotissement Ben Hatadi, Alger, Algerie
ARMENIA	NGYIG Ltd.	47 A/75 St. Lalaiants, 375000 Yerevan, Armenia
AUSTRALIA	QualiFi Pty. Ltd.,	P.O. Box 350, Mt. Waverley, VIC 3149, Australia
AUSTRIA	Huber & Prohaska GmbH	Taborstraße 95 / Ladestraße 1, Gebäude Hangartner, A-1200 Wien, Austria
BAHREIN	Ambassador Stores	P.O. Box 237,141, Government Avenue, Manama,Bahrein
BANGLADESH	Target	1078, Ramjoy Mohanja Lane Asadgonj, Chittagong 4000, Bangladesh
BELGIUM	Van der Heyden Audio N.V.	Brusselbaan 278, 9320 Erembodegem, Belgium
BULGARIA	Ariescommerce GmbH	Makedonia Blvd. 16, 1606 Sofia, Bulgaria
CANADA	Lenbrook Industries Limited	633 Granite Court, Pickering, Ontario
CHINA	Guang Chang Audio International Co., Ltd.	No.38 Yushan Road, ShiQiao, Pan Yu, Guang Dong, China
CYPRUS	Empire Hifi systems Ltd.	P.O. Box 5604, Nicosia, Cyprus
CZECH REPUBLIC	Audio International	Sokolska 41, 67902 Rajecsko, OKR,Blansko, Czech Republic
DENMARK	Audio Nord	Dali Allé 1, 9610 Noerager, Denmark
DUBAI	V.V.& SONS	P.O. Box 105, Dubai, U.A.E.
EGYPT	Solimco	9, El Attibaa St. Doki, Cairo, Egypt
ESTONIA	HiFi Club Estonia	Ehte 4, 90503 Haapsalu, Estonia
F.Y.R.O.M.	T.P. KODI	ul.Cedomir Kantargiev 21a, Skopje, Former Yugoslavian Republic of Macedonija
FINLAND	Audio Nord	Uudenmaankatu 4-6, Helsinki SF-00120, Finland
FRANCE	Marantz France	A division of Marantz Europe B.V., P.O. Box 301, 92 156 Suresnes Cedex, France
GERMANY	Marantz Deutschland	Hakenbusch 3, 49078 Osnabrück, Germany
GREECE	Adamco S.A.	188, Hippocratous Street, 11471 Athens, Greece
HEADQUARTERS EUROPE:	Marantz Europe B.V.	P.O. Box 8744, 5605 LS Eindhoven, The Netherlands
HONG KONG	Marantz Hong Kong Ltd.	Unit 1706, Metroplaza II, 223 Hing Fong Road, Kwai Fong, N.T., Kowloon, Hong Kong
HUNGARY	Infovox Ltd.	Terez Krt.31, 1067 Budapest, Hungary
ICELAND	ID Electronics Ltd.	Armula 38, 108 Reykjavik, Iceland
INDIA	NOVA Audio Private	8,Punam Co-op.Society 29/30 Road#5, Union Park MUMBAI 400052, India
IRAN	Home Co.	5th floor no 878 Philips Building Enghelab ave, P.O. 11365/7844 Tehran, Iran
IRELAND	Marantz Ireland	Clonskeagh, Dublin 14, Ireland
ISRAEL	Elmor Ltd.	52 Heh Beiyar Street, Kikar Hamedina, Tel Aviv, Israel
ITALY	Marantz Italy	Via Casati 23, 20052 Monza (Milano), Italy, Servizio Consumatori 1678-20026, Numero Verde
IVORY COAST	Hifivoir	B.P. 2428, Abidjan 01, Ivory Coast
JAPAN	Marantz Japan Inc.	35-1 Sagami Ohno 7-Chome, Sagamihara-shi, Kanagawa 228-8505, Japan
KOREA	MK Enterprises Ltd.	Rm604, Electro-officetel, 16-58. Hangang-ro 3Ga, Yongsan-Ku, Seoul, Korea
KUWAIT	alAlamiah Electronics Intl.	P.O. Box 8196, Salmiah 22052, Kuwait
LATVIA	Ace Ltd.	61, LacPlesa Str., Riga LV 1011, Latvia
LEBANON	AZ Electronics S.A., 1,	P.O. Box 11 2833, Beirut, Lebanon
LITHUANIA	Accapella Ltd.	Ausros, Vartu G/5, Pasazo SKG., 2001 Vilnius, Lithuania
MALAYSIA	Wo Kee Hong Electronics Sdn. Bhd.	Suite 8.1, Level 8, Menara Genesis, No. 33, Jalan Sultan Ismail, 50250 Kuala Lumpur, Malaysia
MALTA	Doneo Co Ltd.	78 The Strand, Sliema SLM07, Malta
MAURITIUS	SKR Electronics Ltd.	P.O. Box 685, Bell Village, Port Louis, Mauritius
MILITARY MARKET EUROPE	PASCO GmbH	PO BOX 1280, Sandhausen 69200, Germany
NETHERLANDS	Marantz Europe B.V.	P.O. Box 8744, 5605 LS Eindhoven, The Netherlands
NEW ZEALAND	Wildash Audio Systems	14 Malvern Road, Mt. Albert, Auckland, New Zealand
NORWAY	Audio Nord	Sandkerveien 64, Oslo 0483, Norway
OMAN	Mustafa & Jawad Trading CO.	P.O. Box 1918, Ruwi, Oman
POLAND	Philips Polska Sp. z.o.o.	Al.Jerozolimskie 195b, 02 222 Warszawa, Poland
PORTUGAL	Corel2	Comércio de Electrónica Lda., Av. Luís Bivar, No 85 A, 1050 Lisboa, Portugal
PROFESSIONAL EUROPE	Marantz Professional Products	Kingsbridge House, Padbury Oaks, 575-583 Bath Road, Longford, Middlesex UB7 0EH, U.K.
PROFESSIONAL U.S.A.	Marantz Professional Products	Distributed by: Superscope Technologies Inc., 1000 Corporate Blvd. Ste.D, Aurora, Illinois
QATAR	Almana & Partners W.W.L.	P.O. Box 49, Doha, Qatar
REUNION	Vision +	180 Rue du Marechal Leclerc, 97400 Saint Denis, Ile de la Reunion
ROMANIA	Nova Music Entertainment	5, Zagazului Str. Bl.1G,apt.18, sector 1,Bucharest, Romania
RUSSIA	Absolute Audio	7/2, Montazhnaya Street, 107497 Moscow, Russia
SAUDI ARABIA	Adawlia Univ. Electr. Apl	P.O. Box 2154, Alkhobar 31952, Saudi Arabia
SINGAPORE	Wo Kee Hong Distribution PTE Ltd.	130 Joo Seng Road, #03-02 Olivine Building, Singapore 368357
SLOVAKIA	Bis Audio s.r.o.	Nam. SNP 10, 96001 Zvolem, Slovakia
SLOVENIA	Bofex	Smartinska 152, HALA V/3, 61000 Ljubljana, Slovenia
SOUTH AFRICA	Coherent Imports (PTY) Ltd.	P.O. Box 1614, Alberton, 1450, South Africa
SPAIN	Marantz Spain	Martinez Villergas 2, Apartado 2065, Madrid 28027, Spain
SRI LANKA	The listening Room	Mezzanine Floor, The Landmark 385, Galle Road, Colombo - 3, Sri Lanka
SWEDEN	Audio Nord	Almedalsvagen 4, Gotenborg 402-23, Sweden
SWITZERLAND	Sound Company AG	Postfach, 8010 Zürich, Switzerland
SYRIA	Hamzeh & Partners	Hafez Ibrahim Str. No 117, Damascus Shalan, Syria
TAHITI	Covecolor	Av. Prince Hinoi, Cours de l'union sacré, P.O. Box 2334, Papeete, Tahiti
TAIWAN	Pai-Yuing Co. Ltd.	6th No 148 Sung Kiang Road, Taipei 10429, Taiwan R.O.C.
THAILAND	MRZ Standard Co. Ltd.	746-750 Mahachai Road, Wangburapa, Bangkok 10200, Thailand
TUNESIA	Societe EDEVIG	40, Avenue du Golfe Arabe, El Menzah, 1004, Tunesia
TURKEY	Türk Philips Ticaret A.S.	Yukari Dudullu Organize sanayi Bolgesi, 2.Cadde no.28, 81260 Umraniye-Istanbul, Turkey
U.K.	Marantz Hifi UK Ltd.	Kingsbridge House, Padbury Oaks, 575-583 Bath Road, Longford, Middlesex UB7 0EH, U.K.
U.S.A.	Marantz America Inc.	1100 Maplewood Drive Itasca, IL 60143, U.S.A.
YUGOSLAVIA	ITM Company	Omladinskih Brigada 86, 11070 Belgrade, Yugoslavia

www.marantz.com

Manufactured under license from Dolby Laboratories. "Dolby", "Pro Logic", and the double-D symbol are trademarks of Dolby Laboratories. "DTS", "DTS-ES Extended Surround" and "Neo:6" are trademarks of Digital Theater Systems, Inc.

**marantz**® is a registered trademark.

